

2011

Product Catalog

ROHM
SEMICONDUCTOR

Opto Electronics

LEDs



Contents

SMD LEDs

〈1006 Type〉	SML-P1 (PICOLED™-eco/PICOLED™).....	2
〈1608 Type〉	SML-E1 (EXCELED™).....	4
	SML-D1/51.....	6
	SML-31.....	8
〈2012 Type〉	SML-21.....	10
〈Reflector Type〉	SML-M1/T1.....	12
	SML-01.....	14
	SML-Z1 (PLCC2).....	16
〈Side-View Type〉	SML-R1 (PICOLED™-side).....	18
	SML-A1.....	20
	SMLF1.....	22
	SMLC1.....	23
	SML-11.....	24
〈Reverse-Mount Type〉	SML-81.....	26
〈Surface Mount Circular Type〉	SML-L1/J1.....	28
〈Multi-Color Type〉	SML-P24 (PICOLED™-Duo).....	30
	SML-52.....	32
	SML-02.....	34
	SMLP3 (PICOLED™-RGB).....	36
	SML032RGB.....	38

Through-hole LEDs

〈φ3 Type〉	SLR343/SLI-343/SLI-343(W) (High Brightness/Low Current Consumption).....	40
	SLR-343 (Standard).....	42
	SLI-343□8 (EXCELED™).....	44
	SLA-370/SLA-360 /SLR-342/SLR-332.....	46
〈φ5 Type〉	SLI-580/SLA-580/SLA580.....	48
	SLI-570/SLA-570 /SLI-560/SLA-560.....	50
	SLA560/SLR-56.....	52
〈Special Type〉	SLI-325/SLR-325.....	54
	SLR-322.....	56
	SLC-22.....	58
	SLB-25.....	59
	SPR-39/SPR-54.....	60
	Part No. List.....	62
	Part No. Structure.....	64

* PICOLED™ and EXCELED™ are ROHM's pending trademark.

1006(0402) size PICOLED™ -eco / PICOLED™

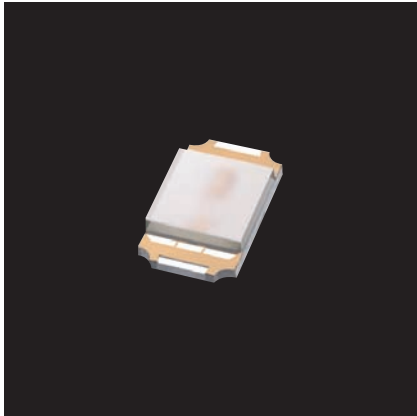

SML-P1 Series

Actual Size
 • 1006(0402)
 1.0×0.6mm(t=0.2mm)

Features

- Ultra compact, thin size 1.0×0.6mm
- Thinnest size in the world* t=0.2mm
- Original device technology enables high brightness and high reliability
- Accomplishes low power consuming application
- Specification assured at If=1mA (PICOLED™-eco)

Color Type	V	U	D	Y
	M	P	B	W
				HB

* Investigated Aug. 2009

Specifications

PICOLED™-eco

Part No.	Chip Structure	Emitting Color	Absolute Maximum Ratings (Ta=25°C)					Electrical and Optical Characteristics (Ta=25°C)														
			Power Dissipation Pd(mW)	Forward Current If(mA)	Peak Forward Current Ifp(mA)	Reverse Voltage Vr(V)	Operating Temperature Topr(°C)	Storage Temperature Tstg(°C)	Forward Voltage Vf		Reverse Current Ir		Dominant Wavelength λ D			Luminous Intensity Iv						
							Typ.(V)	If(mA)	Max.(μA)	Vr(V)	Min.*2 (nm)	Typ.*2 (nm)	Max.*2 (nm)	If(mA)	Min. (mcd)	Typ. (mcd)	If(mA)					
■ SML-P11VT	AlGaInP on GaAs	Red	50	20	100*1	5	-40 to +85	-40 to +100	1.8						1	3.6						
■ SML-P11UT																		621	626	631	1.6	5.5
■ SML-P11DT	AlGaInP on GaAs	Orange	52	20	100*1	5	-40 to +85	-40 to +100	1.9	1	10	4			1	7.3	1					
■ SML-P11YT		Yellow																583	586	589	2.5	7.6
■ SML-P11MT		Yellowish Green																566	569	572	0.63	2.1

* 1:Duty1/10, 1kHz * 2:Reference

PICOLED™

Part No.	Chip Structure	Emitting Color	Absolute Maximum Ratings (Ta=25°C)					Electrical and Optical Characteristics (Ta=25°C)													
			Power Dissipation Pd(mW)	Forward Current If(mA)	Peak Forward Current Ifp(mA)	Reverse Voltage Vr(V)	Operating Temperature Topr(°C)	Storage Temperature Tstg(°C)	Forward Voltage Vf		Reverse Current Ir		Dominant Wavelength λ D			Luminous Intensity Iv					
							Typ.(V)	If(mA)	Max.(μA)	Vr(V)	Min.*2 (nm)	Typ.*2 (nm)	Max.*2 (nm)	If(mA)	Min. (mcd)	Typ. (mcd)	If(mA)				
■ SML-P12VT	AlGaInP on GaAs	Red	50	20	100*1	5	-40 to +85	-40 to +100	2.0						25	85					
■ SML-P12UT																		625	630	635	40
■ SML-P12DT	AlGaInP on GaAs	Orange	52	20	100*1	5	-40 to +85	-40 to +100	2.1	20	4			20	40	100	20				
■ SML-P12YT		Yellow																587	590	593	130
■ SML-P12MT		Yellowish Green																569	572	575	10
■ SML-P12PT		Green	54	20	100*1	5	-40 to +85	-40 to +100	2.2			557	560	563	4.0	13					
■ SMLP12BC7T	InGaN on SiC	Blue	66	20	100*1	5	-40 to +85	-40 to +100	2.9	5	5			5	36	71	5				
□ SMLP12WBC7W		White																(x, y) (0.30, 0.30)	14	22	
■ SMLP12HBC7W		Pink																(x, y) (0.23, 0.10)	14	22	

* 1:Duty1/10, 1kHz * 2:Reference

Dimensions

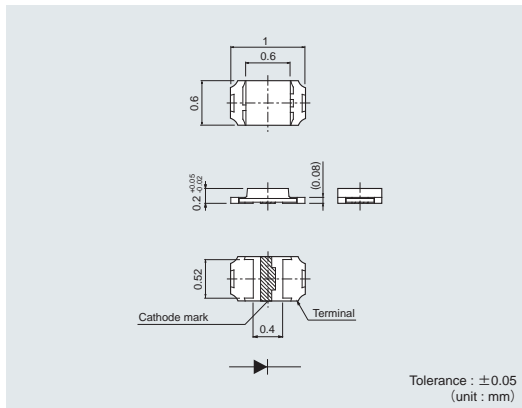

Recommended Solder Pattern Viewing Angle

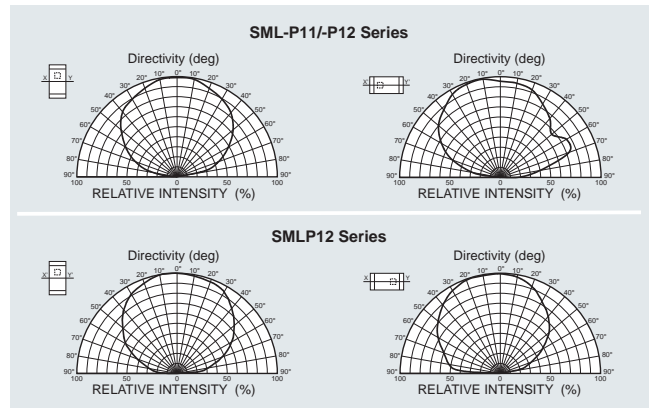
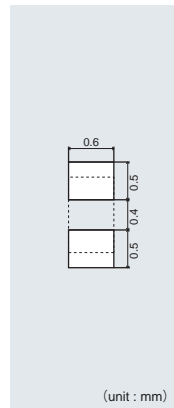

* PICOLED™ is ROHM's pending trademark.

Electrical Characteristics Curves

Forward Current-Forward Voltage

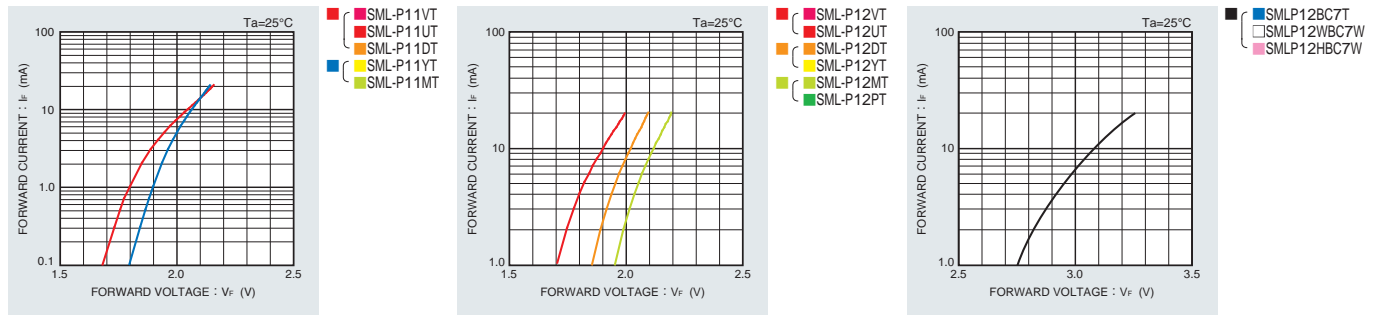

Luminous Intensity-Atmosphere Temperature

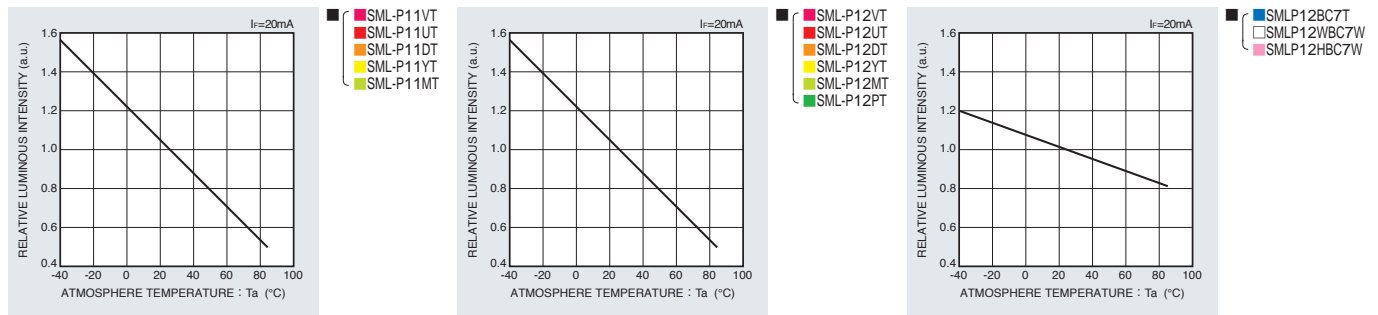

Luminous Intensity-Forward Current

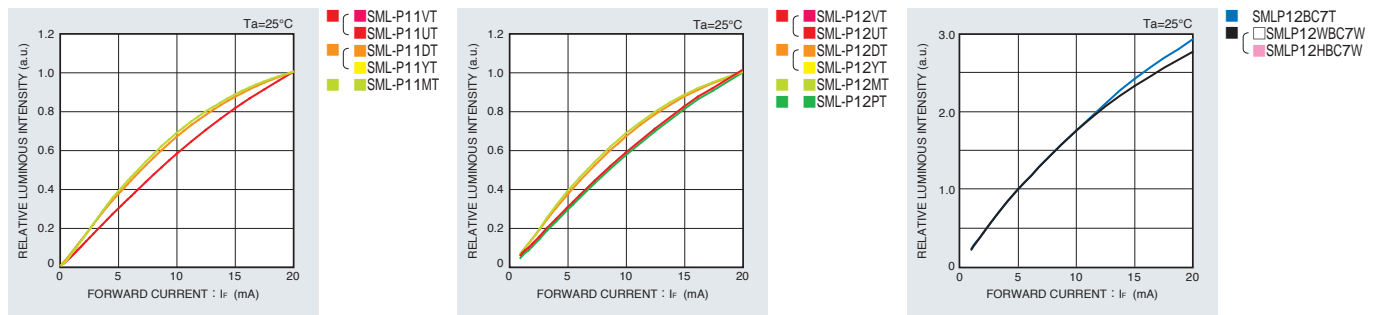

Derating

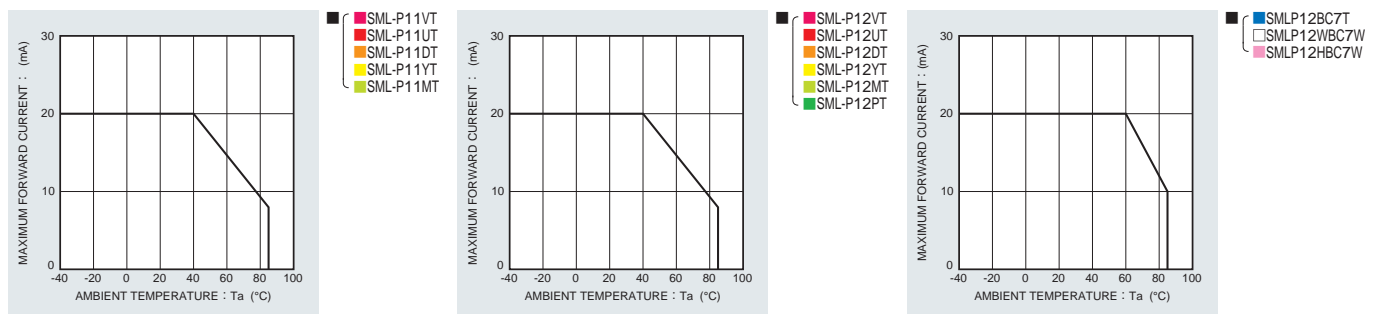

1608(0603) size EXCELED™

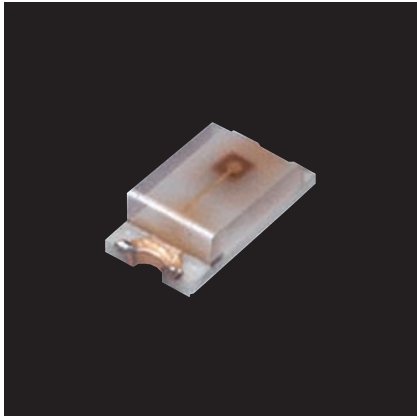

SML-E1 Series

Actual Size
 ◆ 1608(0603)
 1.6×0.8mm(t=0.36mm)

Features

- EXCELED™ series
- Compact, Thin size (1.6×0.8mm, t=0.36mm)
- LED die consists of 4 elements
- Original device technology enables high brightness and high reliability

Color Type	V	U	D	Y	
	M	P	E	B	WB

Specifications

Part No.	Chip Structure	Emitting Color	Absolute Maximum Ratings (Ta=25°C)						Electrical and Optical Characteristics (Ta=25°C)										
			Power Dissipation Pd(mW)	Forward Current IF(mA)	Peak Forward Current I _{FP} (mA)	Reverse Voltage VR(V)	Operating Temperature Topr(°C)	Storage Temperature Tstg(°C)	Forward Voltage VF Typ.(V)	IF(mA)	Reverse Current IR Max.(μA)	VR(V)	Dominant Wavelength λ D Min.*3 Typ. Max.*3			Luminous Intensity Iv Min. Typ. I _v (mA)			
■ SML-E12V8W	AlGaInP on GaAs	Red	54	20	100*2	5	-40 to +85	-40 to +100	2.2				625	630	635		16	40	
■ SML-E12UW			62	25	60*1	4	-30 to +85	-40 to +85	2.1				619	624	629		36	100	
■ SML-E12U8W			54	20	100*2	5	-40 to +85	-40 to +100	2.2				615	620	625		25	63	
■ SML-E12DW	AlGaInP on GaAs	Orange	62	25	60*1	4	-30 to +85	-40 to +85	1.9	20	4	10	604	606.5	610	20	56	200	20
■ SML-E12D8W			62						602				605	608	40		100		
■ SML-E12Y8W			54						2.2								587	590	
■ SML-E12M8W		Yellowish Green										569	572	575		10	25		
■ SML-E12P8W		Green		20	100*2	5		-40 to +100					557	560	563		2.5	6.3	
■ SMLE12EC6T	InGaN on SiC	Bluish Green	68						3.0				520	527	535		36	85	
■ SMLE12BC7T			66						2.9	5	5		464	470	476	5	9	22	5
□ SMLE12WBC7W				White								100		(x, y) (0.30, 0.30)		22	71		

* 1:Duty1/5, 200Hz * 2:Duty1/10, 1kHz * 3:Reference

Dimensions

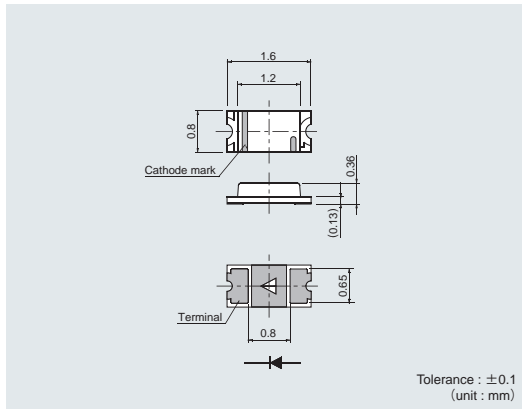

Recommended Solder Pattern Viewing Angle

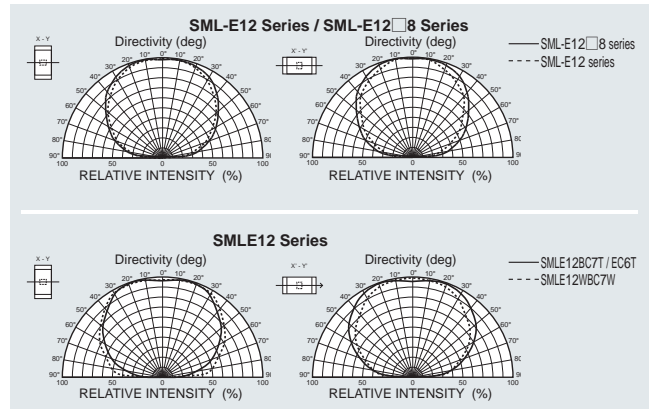
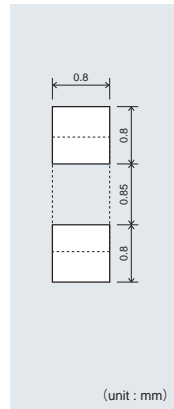

* EXCELED™ is ROHM's pending trademark.

Electrical Characteristics Curves

Forward Current-Forward Voltage

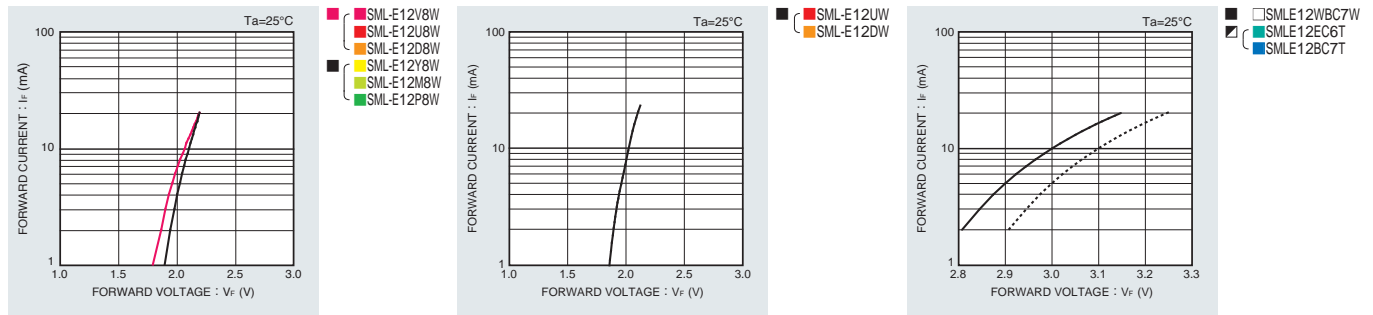

Luminous Intensity-Atmosphere Temperature

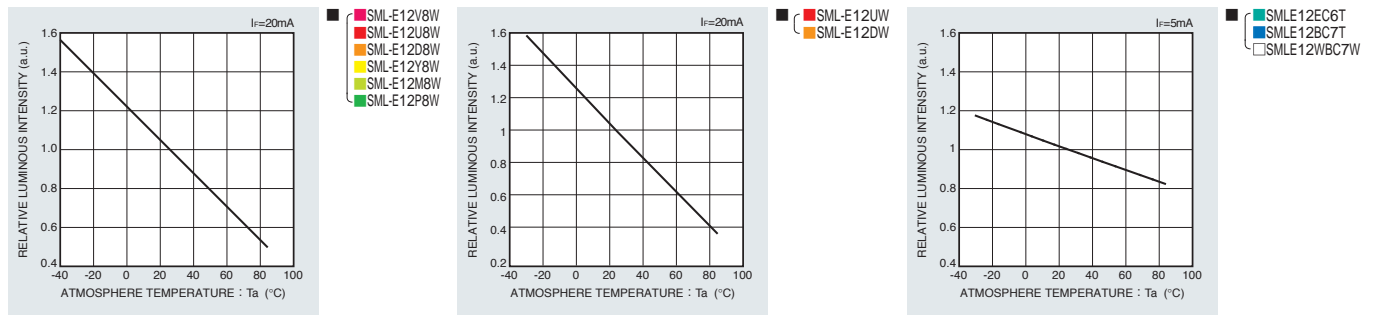

Luminous Intensity-Forward Current

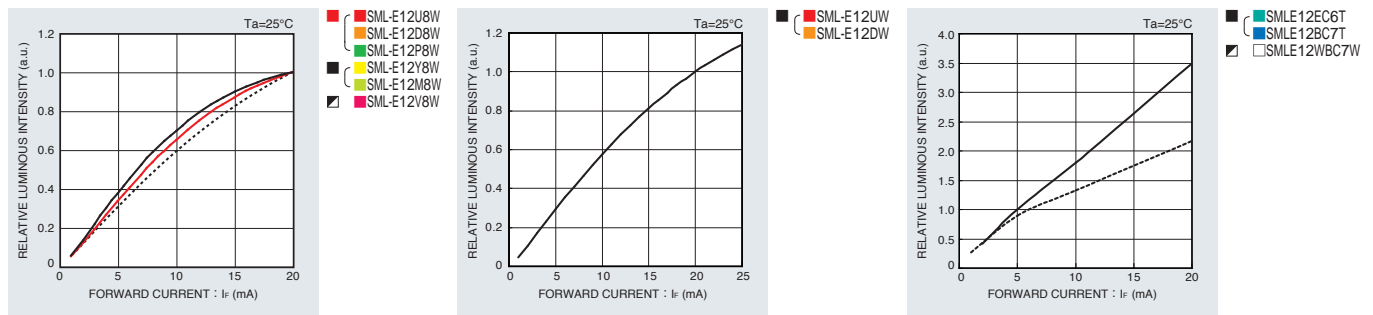

Derating

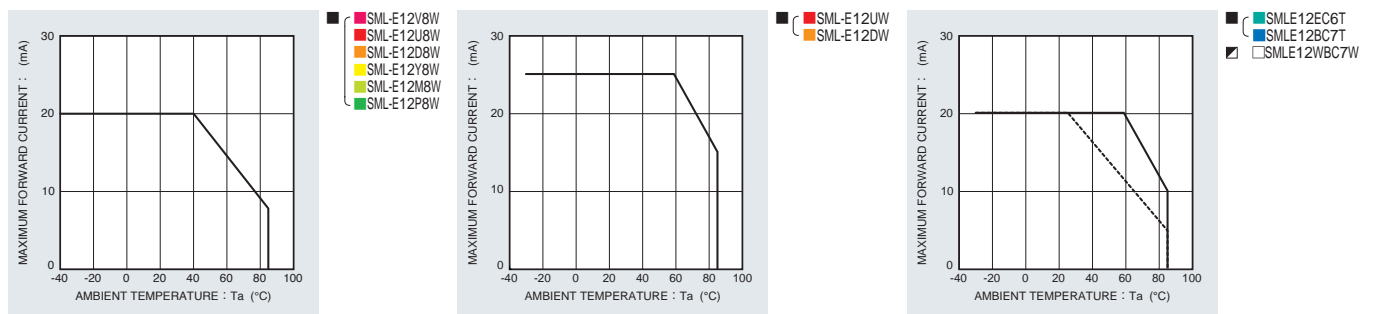

1608(0603) size



SML-D1 Series / SML-51 Series

Actual Size
 1608(0603)
 1.6×0.8mm(t=0.55mm)

Features

- EXCELED™ series (SML-D1 series)
- Original device technology enables high brightness and high reliability
- High reliability due to the wide operation temperature(-40°C to +100°C) : BML-51 series (A)



Specifications

Part No.	Chip Structure	Emitting Color	Absolute Maximum Ratings (Ta=25°C)					Electrical and Optical Characteristics (Ta=25°C)											
			Power Dissipation Pd(mW)	Forward Current IF(mA)	Peak Forward Current I _{FP} (mA)	Reverse Voltage VR(V)	Operating Temperature Topr(°C)	Storage Temperature Tsig(°C)	Forward Voltage VF Typ.(V)	IF(mA)	Reverse Current IR Max.(μA)	VR(V)	Dominant Wavelength λ D Min. nm			Typ. nm	Max. nm	Luminous Intensity Iv (mcd)	
SML-D12V8W	AlGaInP on GaAs	Red	54	20	100*1	5	-40 to +85	-40 to +100	2.2	20	10	4	625	630	635	20	16	40	20
SML-D12U8W		Red											615	620	625		25	63	
SML-D12D8W		Orange											602	605	608		40	100	
SML-D12Y8W		Yellow											587	590	593		25	63	
SML-D12M8W		Yellowish Green											569	572	575		10	25	
SML-D12P8W		Green											557	560	563		2.5	6.3	
SMLD12HBC7W	InGaN on SiC	Pink	66						2.9	5		5	(x, y) (0.47, 0.25)	5	-	22	5		
SML-512VW(A)	AlGaInP on GaAs	Red	75	30	100*2	5	-40 to +100	-40 to +100	2.0	20	10	5	626	630	636	20	35.5	56	20
SML-512UW													619	624	629		22	63	
SML-511UW													62	25	60*1		4	-30 to +85	
SML-512CW(A)		Orange	75	30	100*2	5	-40 to +100	-40 to +100	2.0	20	10	5	600	603	606	20	71	112	20
SML-512DW													603	606	609		36	100	
SML-511DW		62	25	60*1	4	-30 to +85	-40 to +85	100	4	602	605	608	14	40					
SML-512WW		Yellow	75	30	100*2	5	-40 to +100	-40 to +100	2.1	100	10	5	587	590	593	20	36	63	20
SML-511WW													62		60*1		4	-30 to +85	
SML-512MW		Yellowish Green	65	25						2.1		100	567	570	575	20	14		20
SML-512PW(A)		Green			100*2	5				2.1		100	557	560	563		5.6	14	
SML512BC5T	InGaN on SiC	Blue	66	20					2.9	5			464	470	476	5	16	5	

* 1:Duty1/5, 200Hz * 2:Duty1/10, 1kHz * 3:Reference

Dimensions

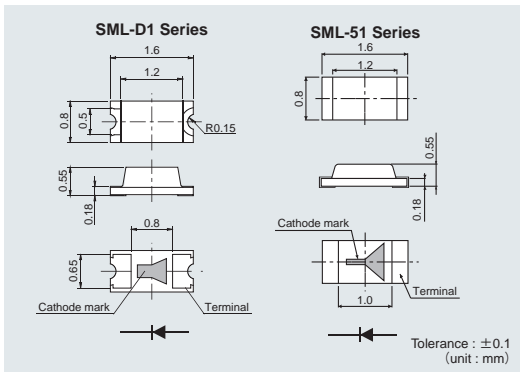

Recommended Solder Pattern Viewing Angle

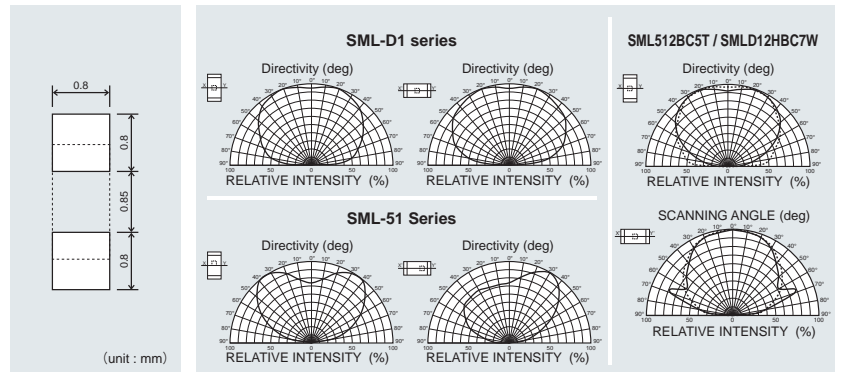

* EXCELED™ is ROHM's pending trademark.

Electrical Characteristics Curves

Forward Current-Forward Voltage

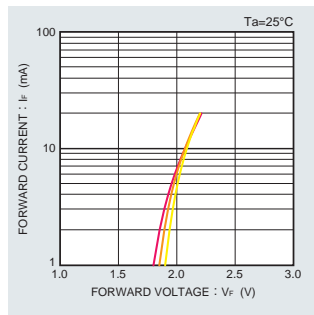

- SML-D12V8W
- SML-D12U8W
- SML-D12D8W
- SML-D12Y8W
- SML-D12M8W
- SML-D12P8W

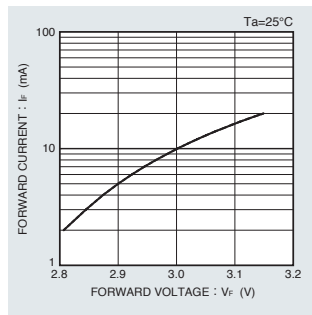

- SML512BC5T
- SMLD12HBC7W

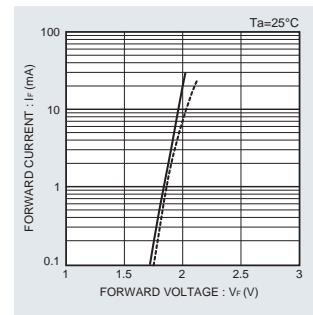

- SML-512VW(A)
- SML-512UW
- SML-512D(A)
- SML-512DW
- SML-512WW
- SML-512W(A)
- SML-512CW(A)
- SML-512D(A)
- SML-512DW
- SML-512MW
- SML-512PW(A)

Luminous Intensity-Atmosphere Temperature

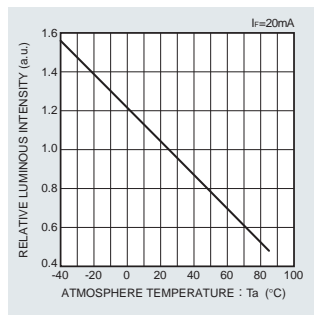

- SML-D12V8W
- SML-D12U8W
- SML-D12D8W
- SML-D12Y8W
- SML-D12M8W
- SML-D12P8W

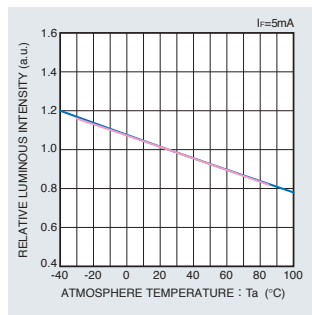

- SML512BC5T
- SMLD12HBC7W

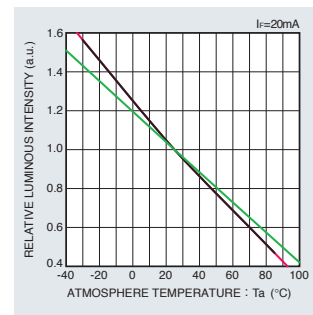

- SML-511W
- SML-511D(A)
- SML-511WW
- SML-512M(A)
- SML-511PW(A)
- SML-512VW(A)
- SML-512UW
- SML-512CW(A)
- SML-512D(A)
- SML-512WW

Luminous Intensity-Forward Current

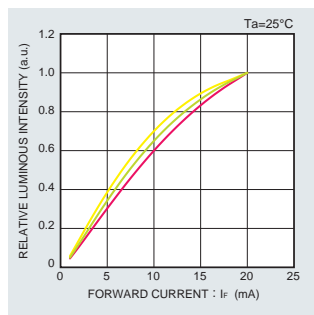

- SML-D12V8W
- SML-D12U8W
- SML-D12D8W
- SML-D12Y8W
- SML-D12M8W
- SML-D12P8W

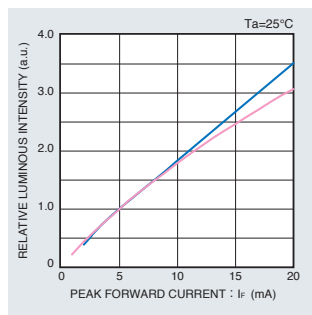

- SML512BC5T
- SMLD12HBC7W

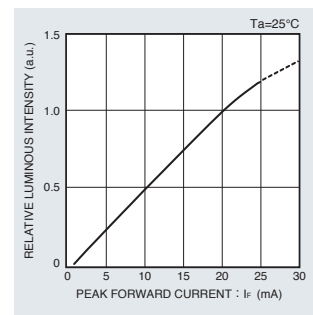

- SML-512VW(A)
- SML-512UW
- SML-512CW(A)
- SML-512D(A)
- SML-512WW
- SML-511UW
- SML-511D(A)
- SML-511WW
- SML-512MW
- SML-511PW(A)

Derating

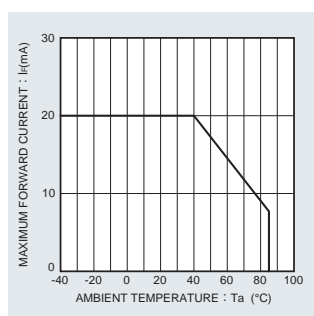

- SML-D12V8W
- SML-D12U8W
- SML-D12D8W
- SML-D12Y8W
- SML-D12M8W
- SML-D12P8W

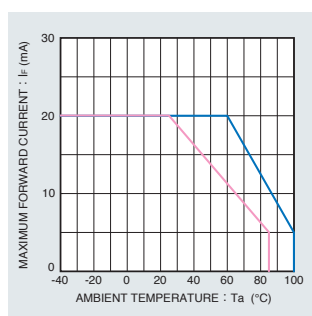

- SML512BC5T
- SMLD12HBC7W

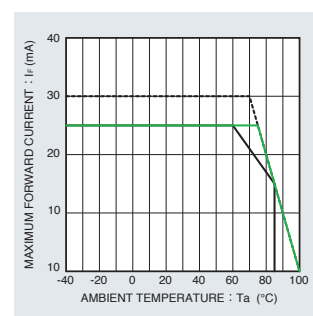

- SML-511W
- SML-511D(A)
- SML-511WW
- SML-512VW(A)
- SML-512UW
- SML-512CW(A)
- SML-512D(A)
- SML-512WW
- SML-512MW
- SML-511PW(A)

1608(0603) size

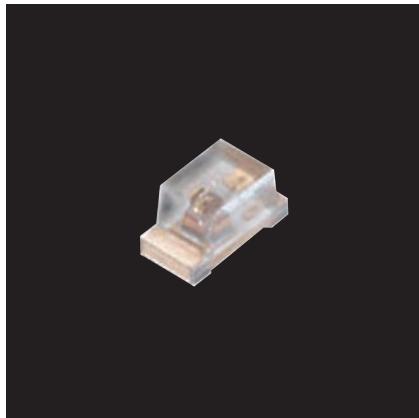

SML-31 Series

Actual Size
 1608(0603)
 1.6×0.8mm(t=0.8mm)

Features

- 1608 standard size (1.6×0.8mm, t=0.8mm)
- Abundant color variations with diverse luminous intensity types



Specifications

Part No.	LED chip	Emitting color	Absolute maximum ratings (Ta=25°C)					Electrical and optical characteristics (Ta=25°C)										
			Power dissipation PD(mW)	Forward current IF(mA)	Peak forward current IFP(mA)	Reverse voltage VR(V)	Operating temperature Topr(°C)	Storage temperature Tstg(°C)	Forward voltage VF		Reverse current IR		Dominant wavelength λ D			Luminous intensity Iv		
							Typ.(V)	IF(mA)	Max.(μA)	VR(V)	Min.(nm)	Typ.(nm)	Max.(nm)	IF(mA)	Min.(mcd)	Typ.(mcd)	IF(mA)	
■ SML-310VT	GaAsP on GaP	Red	55				2	20			625	630	635	20	1.4	4	20	
■ SML-311UT	AlGaInP on GaAs			44				1.8	2			615	620	625	2	0.9	2.5	2
■ SML-311DT			Orange									602	605	608		1.6	3.15	
■ SML-310DT	GaAsP on GaP			55				2	20					20	2.2	6.3	20	
■ SML-311WT	AlGaInP on GaAs	Yellow	44		60*1	4		-40 to +85	1.8	2	4	587	590	593	2	0.9	2.5	2
■ SML-311YT													584	587	590		2.2	6.3
■ SML-310YT	GaAsP on GaP			20				2.1										
■ SML-310MT	GaP	Yellowish Green	55							100		567	570	573		3.6	16	
■ SML-310PT		Green							2.2				557	560	563		1.4	4
■ SML312ECT		Bluish Green						3.3	20			520	527	535	20	90	200	20
■ SML312EC4T								3.2			525		36			90		
■ SML312BCT	InGaN on SiC	Blue			100*2			3.3		5		464	470	476		22	63	
■ SML312BC4T								3.2								46		
■ SML310BAT					94		70*2			3.8				460	466	472		1.4
□ SML312WBCW(A)		White	108	30	100*2			-40 to +100	3.0	5		(x, y)	(0.30, 0.29)	5	45	71	5	

*1:Duty1/5, 200Hz *2:Duty1/10, 1kHz

Dimensions

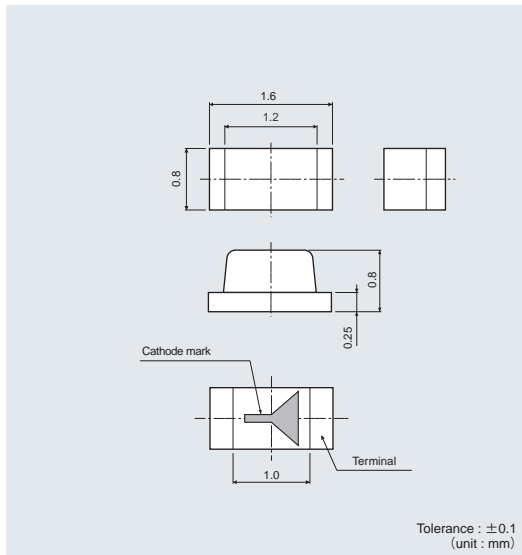

Recommended Solder Pattern Viewing Angle

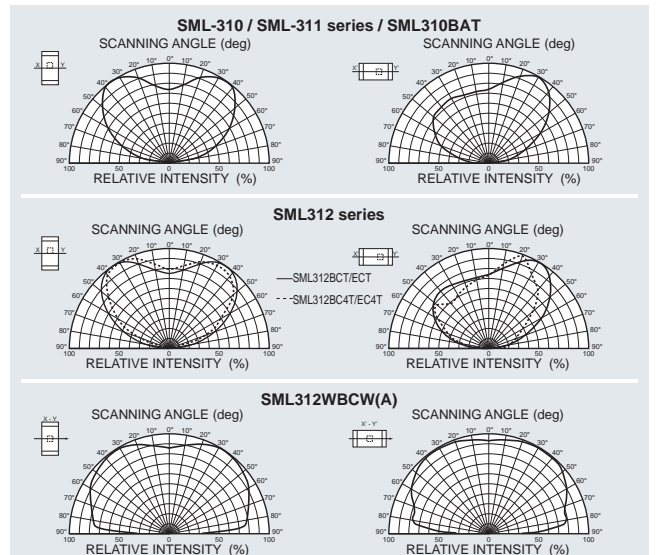
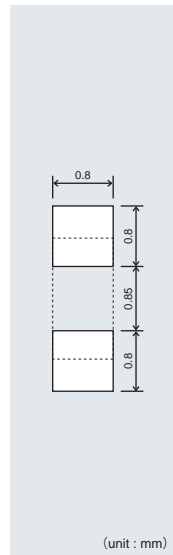

Electrical Characteristics Curves

Forward Current-Forward Voltage

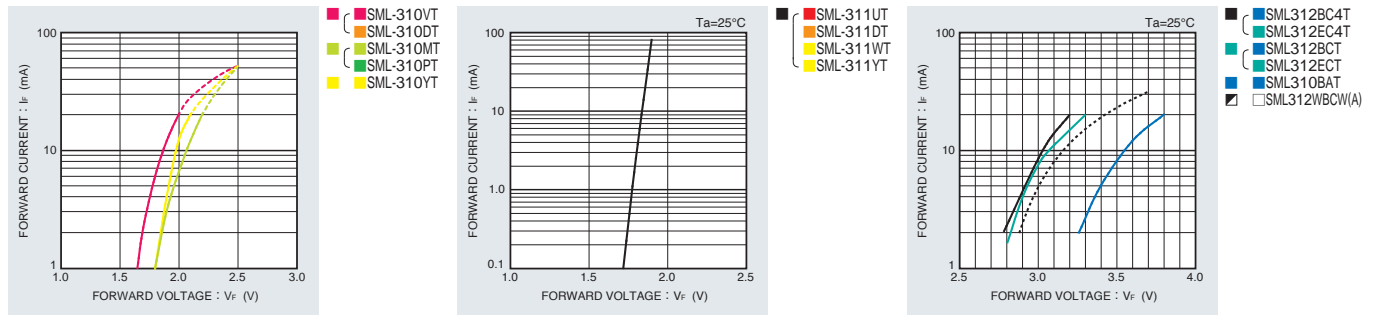

Luminous Intensity-Atmosphere Temperature

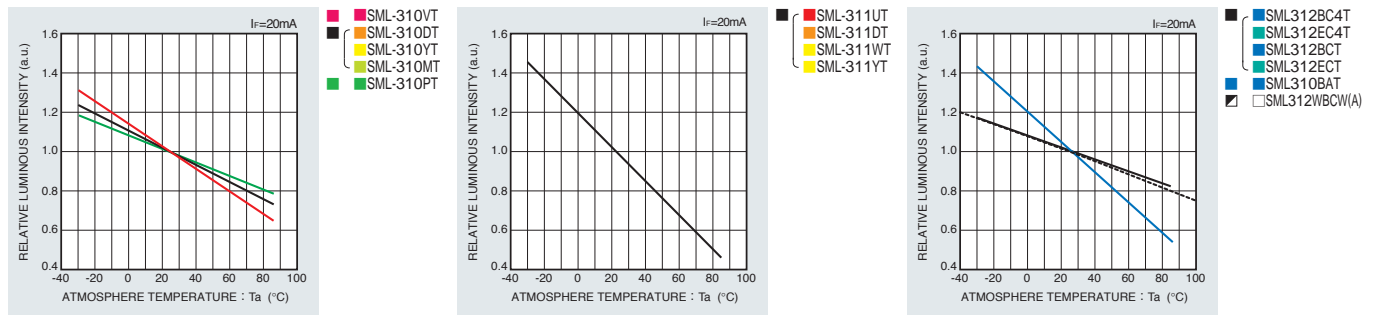

Luminous Intensity-Forward Current

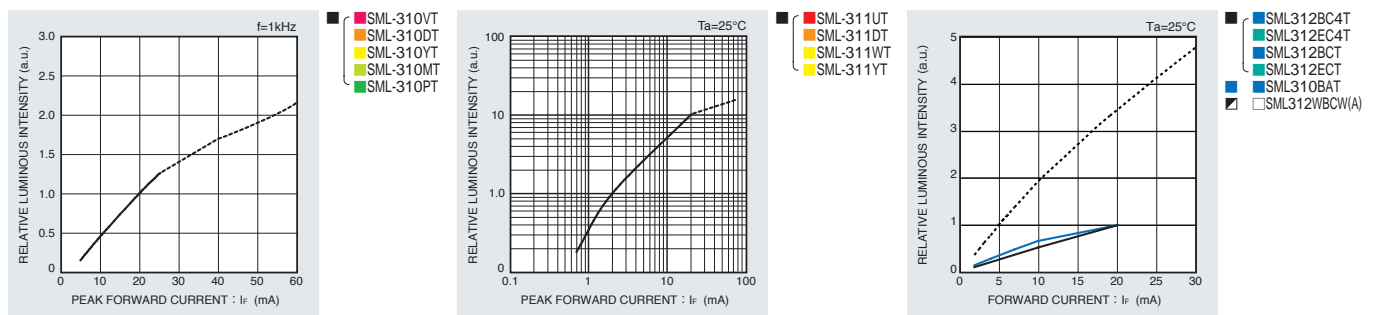

Deratings

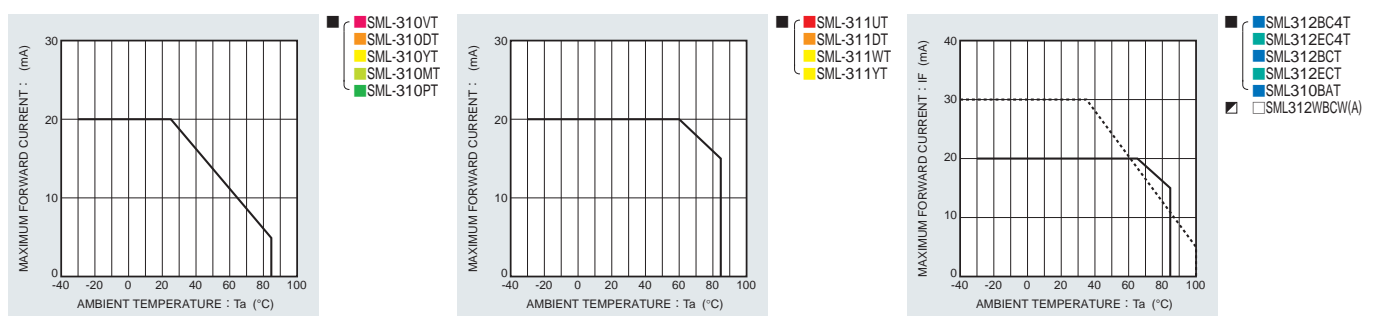

2012(0805) size

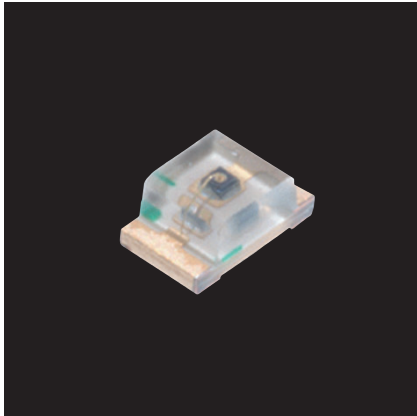

SML-21 Series

Actual Size
 2012(0805)
 2.0 × 1.25mm (t=0.8mm)

Features

· Abundant color variations with diverse luminous intensity types



Specifications

Part No.	Chip Structure	Emitting Color	Absolute Maximum Ratings (Ta=25°C)					Electrical and Optical Characteristics (Ta=25°C)											
			Power Dissipation Pd (mW)	Forward Current If (mA)	Peak Forward Current Ifp (mA)	Reverse Voltage VR (V)	Operating Temperature Topr (°C)	Storage Temperature Tstg (°C)	Forward Voltage VF		Reverse Current IR		Dominant Wavelength λ D			Luminous Intensity Iv			
								Typ. (V)	If (mA)	Max. (μA)	VR (V)	Min.*3 (nm)	Typ. (nm)	Max.*3 (nm)	If (mA)	Min. (mcd)	Typ. (mcd)	If (mA)	
■ SML-212VT	AlGaInP on GaAs	Red	75	30	60*1	4	-30 to +85	-40 to +85	2.05	20	100	4	625	630	635	20	1.4	4	20
■ SML-210VT	GaAsP on GaP		70	25					75										
■ SML-212U2T(A)			44	20					1.8	2			615	620	625	2	0.9	2.5	2
■ SML-211DT	AlGaInP on GaAs	Orange	75	30	60*1	4	-30 to +85	-40 to +85	2.05	20	100	4				20	25	63	20
■ SML-211DT			44	20															
■ SML-210DT	GaAsP on GaP		70	25													2.2	6.3	
■ SML-212WT(A)		Yellow	75	30	100*2	5	-40 to +100	-40 to +100	2	20	10	5	587	590	593	20	112	224	20
■ SML-211WT	AlGaInP on GaAs		44	20															
■ SML-212YT			75	30					2.05	20						20	22	63	20
■ SML-211YT		Yellowish Green	44	20	60*1	4	-30 to +85	-40 to +85	1.8	2	100	4	584	587	590	2	1.4	4	2
■ SML-210YT	GaAsP on GaP		70	25															
■ SML-210MT	GaP	Green	70	25					2.2	20			567	570	573	20	3.6	16	20
■ SML-210PT																			

*1:Duty1/5, 200Hz *2:Duty1/10, 1kHz *3:Reference

Dimensions

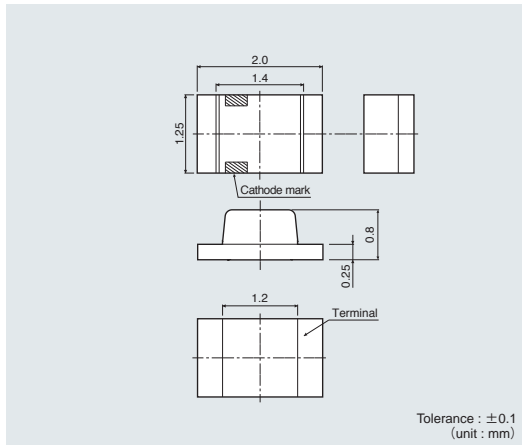

Recommended Solder Pattern Viewing Angle

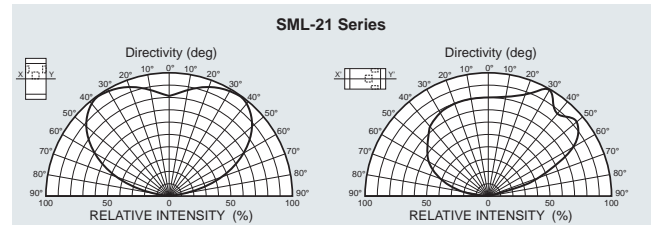
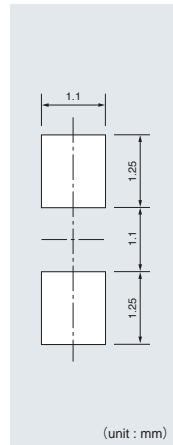

Electrical Characteristics Curves

Forward Current-Forward Voltage

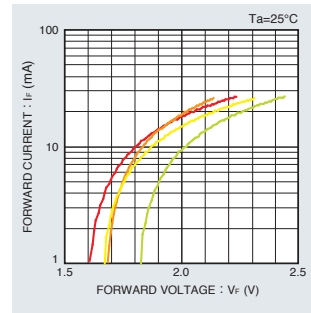
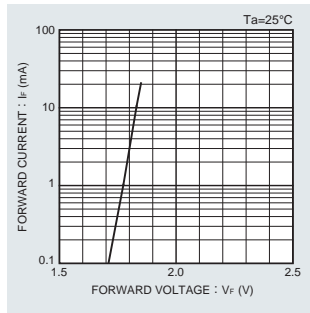
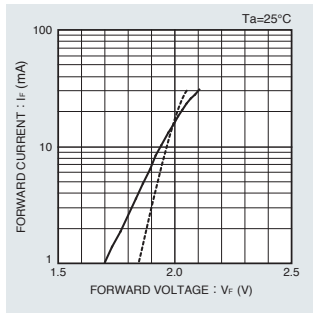

Luminous Intensity-Atmosphere Temperature

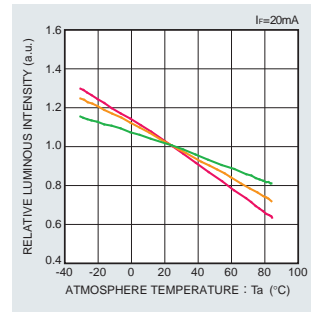
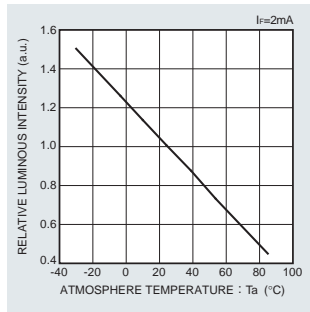
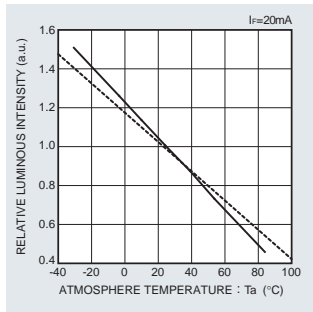

Luminous Intensity-Forward Current

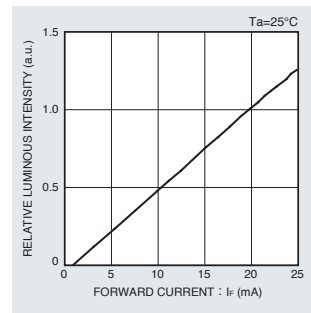
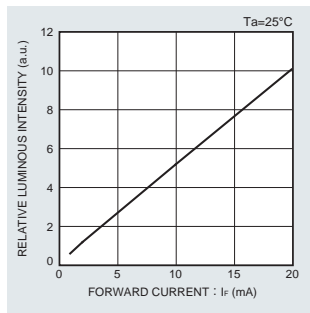
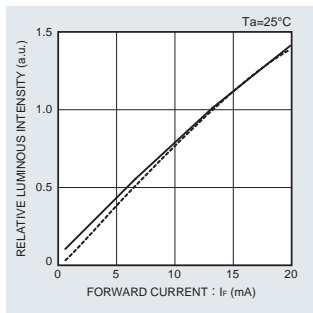

Derating

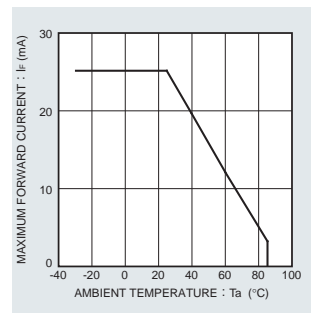
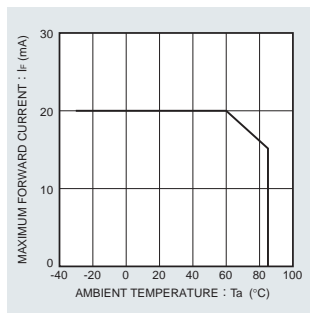
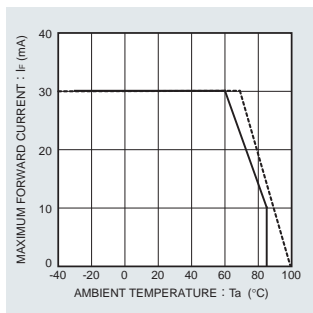

1608(0603) / 2012(0805) size

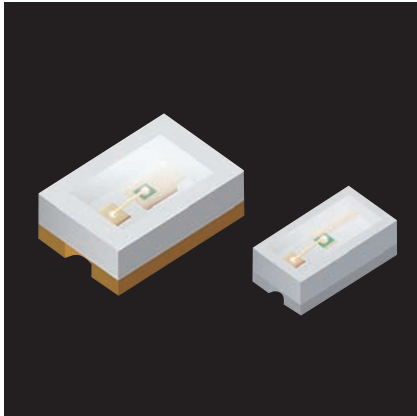

SML-M1/SML-T1 series

SML-M1

Actual Size
 20125(0805)
 2.0×1.25mm(t=0.8mm)

SML-T1

Actual Size
 1608(0603)
 1.6×0.8mm(t=0.55mm)

Features

- Compact LEDs with reflector
- Die is located at the center of the package, achieving equivalent distribution of light emission.
- New emitting color, including the pastel colors available upon request.



Specifications

Part No.	Chip Structure	Emitting Color	Absolute Maximum Ratings (Ta=25°C)					Electrical and Optical Characteristics (Ta=25°C)											
			Power Dissipation Pd(mW)	Forward Current IF(mA)	Peak Forward Current I _{FP} (mA)	Reverse Voltage VR(V)	Operating Temperature Topr(°C)	Storage Temperature Tstg(°C)	Forward Voltage VF Typ.(V)	VF(mA)	Reverse Current IR Max.(μA)	VR(V)	Dominant Wavelength λ D (nm)			Luminous Intensity Iv (mcd)			
SML-M13VT	AlGaInP on GaAs	Red	63	25	100*1	5	-40 to +85	-40 to +100	2.0	20*1	10	5	625	630	635	20	40	75	20
SML-M13UT													615	620	625		63	120	
SML-M13DT													602	605	608		100	200	
SML-M13YT													587	590	593		160		
SML-M13MT													569	572	575		25	45	
SML-M13PT	Green	68	30						2.2				557	560	563		6.3	16	
SMLM12BC7T	InGaN on SiC	Blue	66	20			-30 to +85		2.9	5*1	100	5	465	470	475	5	-	36	5
SMLM12WBC7W		White					-40 to +100												
SML-T13VT	AlGaInP on GaAs	Red	63	25	100*1	5	-40 to +85	-40 to +100	2.0	20*1	10	5	625	630	635	20	40	75	20
SML-T13UT													615	620	625		63	120	
SML-T13DT													602	605	608		100	200	
SML-T13WT													587	590	593		160		
SML-T13YT													584	587	590		25	45	
SML-T13MT	Yellowish Green	68							2.1				569	572	575		16	32	
SML-T13FT	Green								2.2				557	560	563		6.3	16	
SMLT12BC7T	InGaN on SiC	Blue	66	20			-30 to +85		2.9	5*1	100	5	465	470	475	5	14	28	5
SMLT12WBC7W		White																	

*1:Duty1/10, 1KHz *2:Reference

Dimensions

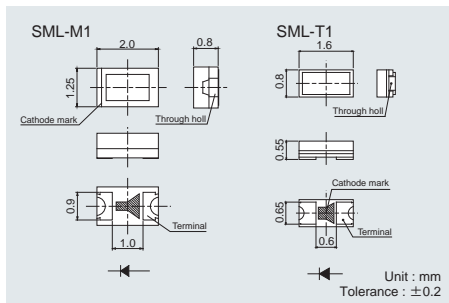

Recommended Solder Pattern

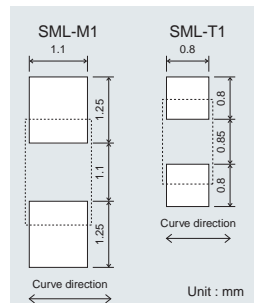

Viewing Angle

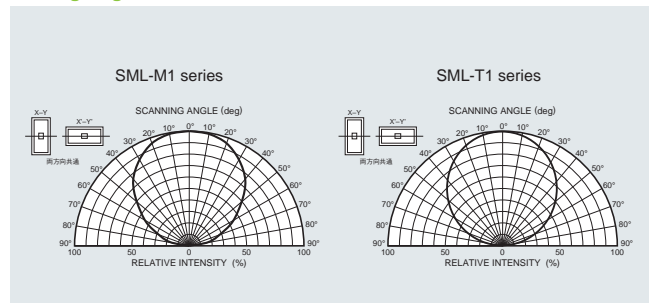

Electrical Characteristics Curves

Forward Current-Forward Voltage

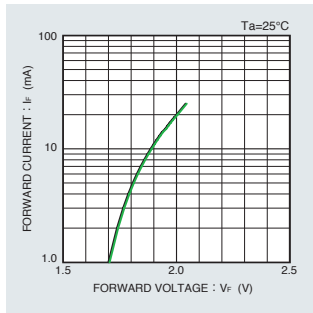

- SML-M13VT
- SML-M13UT
- SML-M13DT
- SML-M13YT
- SML-M13MT
- SML-M13PT

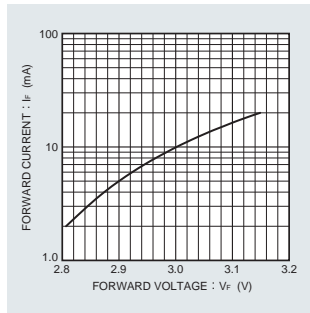

- SMLM12BC7T
- SMLM12VBC7W
- SMLT12BC7T
- SMLT12VBC7W

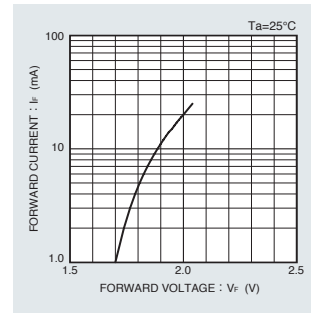

- SML-T13VT
- SML-T13UT
- SML-T13DT
- SML-T13YT
- SML-T13MT
- SML-T13FT
- SML-T13PT

Luminous Intensity-Atmosphere Temperature

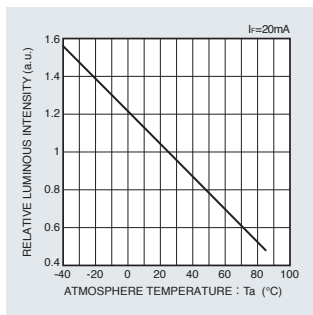

- SML-M13VT
- SML-M13UT
- SML-M13DT
- SML-M13YT
- SML-M13MT
- SML-M13PT

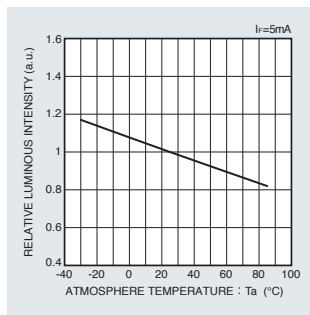

- SMLM12BC7T
- SMLM12VBC7W
- SMLT12BC7T
- SMLT12VBC7W

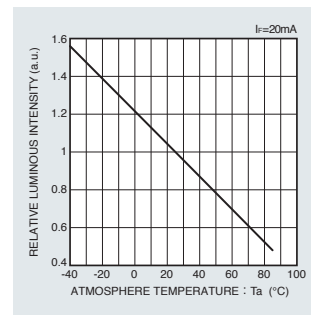

- SML-T13VT
- SML-T13UT
- SML-T13DT
- SML-T13YT
- SML-T13MT
- SML-T13FT
- SML-T13PT

Luminous Intensity-Forward Current

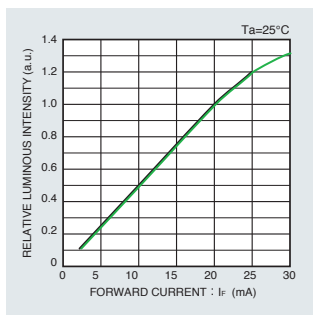

- SML-M13VT
- SML-M13UT
- SML-M13DT
- SML-M13YT
- SML-M13MT
- SML-M13PT

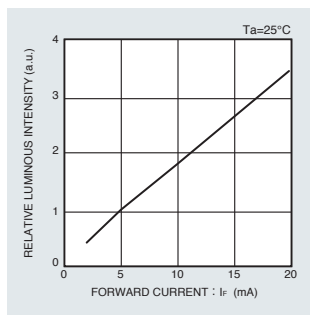

- SMLM12BC7T
- SMLM12VBC7W
- SMLT12BC7T
- SMLT12VBC7W

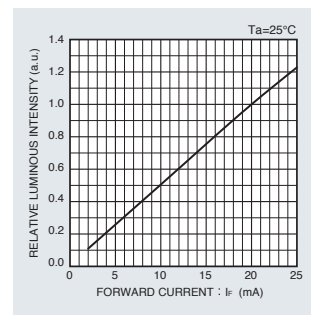

- SML-T13VT
- SML-T13UT
- SML-T13DT
- SML-T13YT
- SML-T13MT
- SML-T13FT
- SML-T13PT

Derating

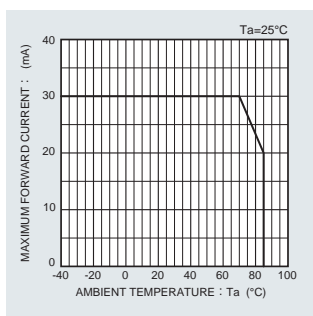

- SML-M13VT
- SML-M13UT
- SML-M13DT
- SML-M13YT
- SML-M13MT
- SML-M13PT

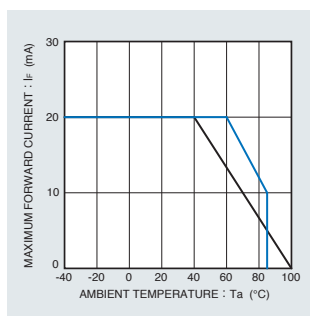

- SMLM12VBC7W
- SMLM12BC7T
- SMLT12BC7T
- SMLT12VBC7W

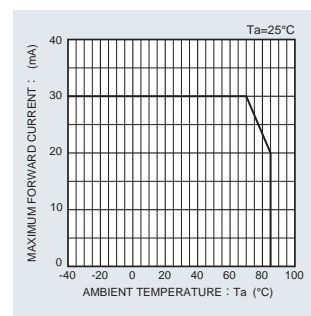

- SML-T13VT
- SML-T13UT
- SML-T13DT
- SML-T13YT
- SML-T13MT
- SML-T13FT
- SML-T13PT

3020(1208) size

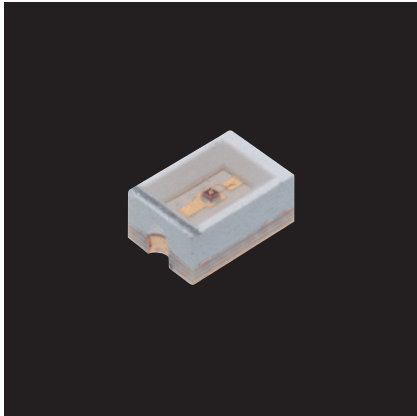

SML-01 Series

Actual Size
 3020(1208)
 3.0×2.0mm(t=1.3mm)

Features

- Reflector type (3.0×2.0mm, t=1.3mm)
- Reflector improved the concentration of viewing angle and luminous intensity to the front direction



Specifications

Part No.	Chip Structure	Emitting Color	Absolute Maximum Ratings (Ta=25°C)					Electrical and Optical Characteristics (Ta=25°C)											
			Power Dissipation Pd(mW)	Forward Current IF(mA)	Peak Forward Current I _{FP} (mA)	Reverse Voltage VR(V)	Operating Temperature Topr(°C)	Storage Temperature Tstg(°C)	Forward Voltage VF Typ.(V)	IF(mA)	Reverse Current IR Max. (μA)	VR(V)	Dominant Wavelength λ D Min.*2 Typ. (nm) Max.*2 (nm)			Luminous Intensity Iv Min. (mcd) Typ. (mcd)		IF(mA)	
SML-012VT(A)	AlGaInP on GaAs	Red	75	30			-40 to +100		2				626	630	636	35.5	71		
SML-012V8T			54	20			-40 to +85		2.2				625	635		25	63		
SML-013UT			75	30			-30 to +85		2				619	624	629	90	220		
SML-012U8T			54	20			-40 to +85		2.2							40	100		
SML-012UT			75	30			-40 to +100		2				615	620	625	36	100		
SML-011UT			75	30			-40 to +100		2							22	63		
SML-012D8T			54	20			-40 to +85		2.2							63	160		
SML-012DT			75	30	100*1		-40 to +100		2	10				602	605	608	36	100	
SML-011DT	InGaN on SiC	Orange	75	30			-40 to +100		2						22	63			
SML-012WT(A)			75	30			-40 to +100		2						140	280			
SML-012Y8T			54	20			-40 to +85		2.2						40	100			
SML-013YT			75	30		5	-40 to +85	-40 to +100	2.1	20	5	587	590	593	20	100	250	20	
SML-012YT			75	30			-40 to +100		2						36	100			
SML-011YT			75	30			-40 to +100		2						22	63			
SML-012M8T			54	20			-40 to +85		2.2					569	572	575	16	40	
SML-012P8T			54	20			-40 to +85		2.2					557	560	563	2.5	6.3	
SML-012PT(A)	62	25	60*1		-40 to +100		2.1					558	564	564	9	18			
SML012ECT	InGaN on SiC	Bluish Green	84						3.3				520	525	535	140	360		
SML012EC4T			84						3.2						56	140			
SML013BDT			78	20	100*1		-30 to +85		3.3	100					90	250			
SML012BCT			84						3.3					465	470	475	36	100	
SML012BC4T			84						3.2							22	36		
SML013WBDW			84						3.2					(x, y) (0.30, 0.30)		360	900		

Dimensions

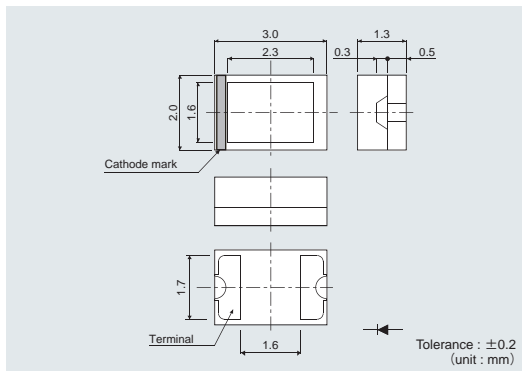

Recommended Solder Pattern

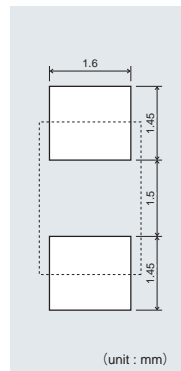

Viewing Angle

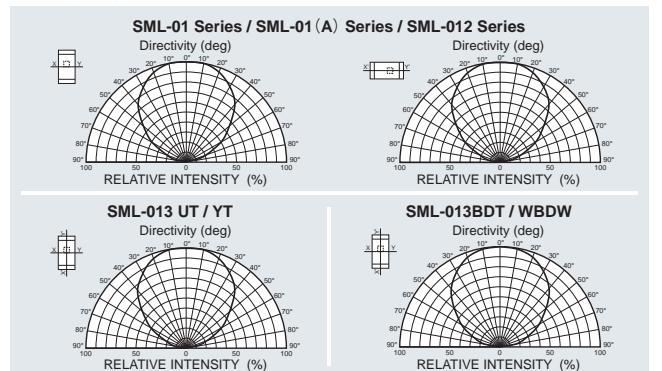

Electrical Characteristics Curves

Forward Current-Forward Voltage

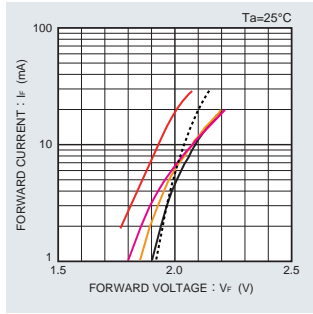

- SML-012V8T
- SML-012U8T
- SML-012J8T
- SML-012D8T
- SML-012Y8T
- SML-012M8T
- SML-012P8T
- SML-013UT
- SML-013YT

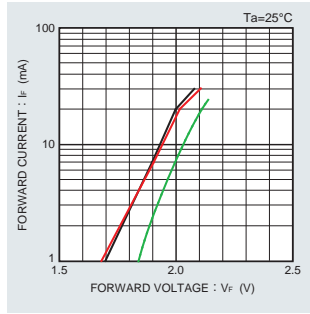

- SML-012V(T)A
- SML-012W(T)A
- SML-012T(A)
- SML-011UT
- SML-012DT
- SML-011DT
- SML-012YT
- SML-011YT
- SML-012PT(A)

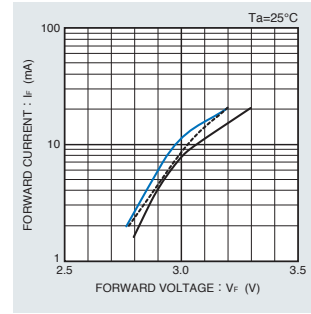

- SML012ECT
- SML012BCT
- SML012EC4T
- SML012BC4T
- SML013BDT
- SML013WBWD

Luminous Intensity-Atmosphere Temperature

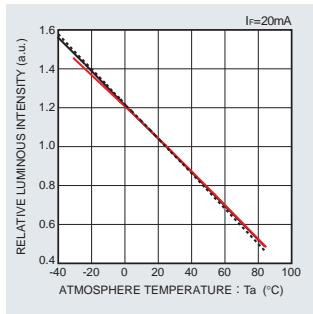

- SML-012V8T
- SML-012U8T
- SML-012D8T
- SML-012Y8T
- SML-012M8T
- SML-012P8T
- SML-013UT
- SML-013YT

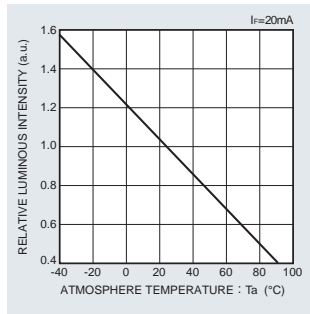

- SML-012V(T)A
- SML-012W(T)A
- SML-012T(A)
- SML-012UT
- SML-011UT
- SML-012DT
- SML-011DT
- SML-012YT
- SML-011YT

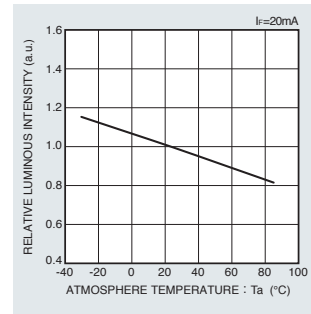

- SML012ECT
- SML012BCT
- SML012EC4T
- SML012BC4T
- SML013BDT
- SML013WBWD

Luminous Intensity-Forward Current

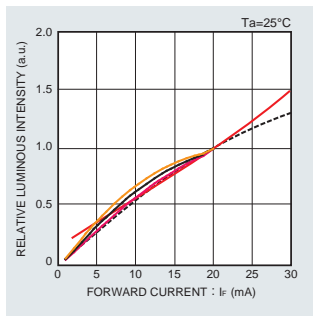

- SML-012V8T
- SML-012U8T
- SML-012D8T
- SML-012Y8T
- SML-012M8T
- SML-012P8T
- SML-013UT
- SML-013YT

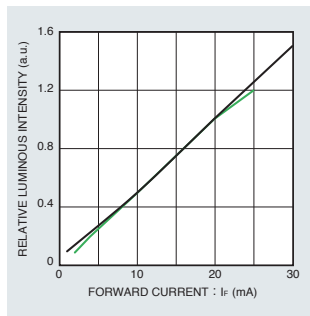

- SML-012V(T)A
- SML-012U8T
- SML-011UT
- SML-012DT
- SML-011DT
- SML-012W(T)A
- SML-012YT
- SML-011YT
- SML-012PT(A)

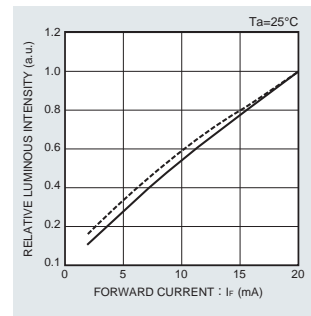

- SML012ECT
- SML012BCT
- SML012EC4T
- SML012BC4T
- SML013BDT
- SML013WBWD

Derating

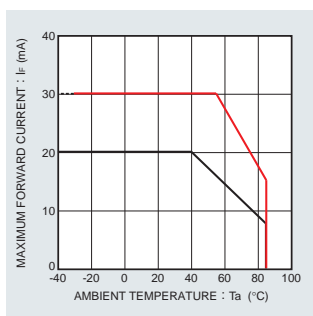

- SML-012V8T
- SML-012U8T
- SML-012D8T
- SML-012Y8T
- SML-012M8T
- SML-012P8T
- SML-013UT
- SML-013YT

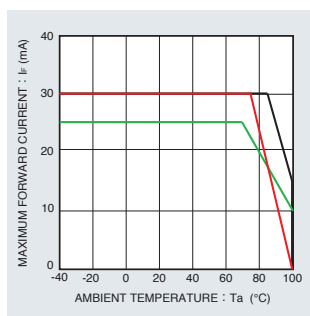

- SML-012V(T)A
- SML-012W(T)A
- SML-012UT
- SML-011UT
- SML-012DT
- SML-011DT
- SML-012YT
- SML-011YT
- SML-012PT(A)

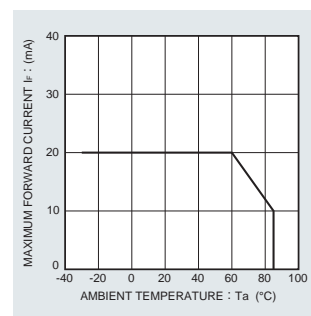

- SML012ECT
- SML012BCT
- SML012EC4T
- SML012BC4T
- SML013BDT
- SML013WBWD

3528(1411) size PLCC2



SML-Z1 Series

Actual Size
 3528(1411)
 3.5×2.8mm(t=1.9mm)

Features

- High brightness
- 20/50mA guaranteed specifications
- PLCC2 package

Color Type	V	U	D	Y	M
	F	P	E	B	WB

Specifications

Part No.	Chip Structure	Emitting Color	Absolute Maximum Ratings (Ta=25°C)					Electrical and Optical Characteristics (Ta=25°C)																
			Power Dissipation Pd (mW)	Forward Current If (mA)	Peak Forward Current I _{FP} (mA)	Reverse Voltage Vr (V)	Operating Temperature Topr (°C)	Storage Temperature Tsig (°C)	Forward Voltage Vf		Reverse Current Ir		Dominant Wavelength λ D			Luminous intensity Iv								
							Typ. (V)	IF (mA)	Max. (μA)	Vr (V)	Min. *2 (nm)	Typ. (nm)	Max. *2 (nm)	IF (mA)	Min. (mcd)	Typ. (mcd)	IF (mA)							
SML-Z14VT(A)	AlGaInP on GaAs	Red	175	70	-	12	-40 to +100	-40 to +100																
SML-Z14UT(A)																			625	630	635	56	112	
SML-Z14DT(A)		Orange																	615	620	625	112	224	
SML-Z14YT(A)																			602	605	608	140	280	20
SML-Z14MT(A)		Yellowish Green																	586	589	592	45	90	
SML-Z14FT(A)		Green																	568	571	574	22.4	45	
SML-Z14PT(A)																			561.5	564	566.5	11.2	22.4	
SML-Z14V4T		Red																	625	630	635	140	280	
SML-Z14U4T																			615	620	625	280	560	
SML-Z14D4T		Orange																	602	605	608	355	710	50
SML-Z14Y4T																			587	590	593	112	224	
SML-Z14M4T		Yellowish Green																	569	572	575	71	120	
SML-Z14F4T		Green																	562	565	568	22.4	56	
SML-Z14P4T																			558	561	564	11.2	22.4	
SML-Z13EDT(A)	InGaP on GaAs	Bluish Green	120	30		5	-40 to +100	-40 to +100	3.3	20	10	5	519	527	536	20	355	710	20					
SMLZ13BDT(A)		Blue							3.2				464	470	476		140	280						
SMLZ14WBECW(A)	InGaP on SiC	White	115	30	100*1	5	-40 to +100	-40 to +100	3.2	20	10	5	(x, y) (0.30, 0.28)			1400	2000							
SMLZ13WBDAW													(x, y) (0.36, 0.36)			360	700	20						
SMLZ13WBDBW													(x, y) (0.44, 0.40)			900	1400							
SMLZ13WBDCW(A)													(x, y) (0.30, 0.28)											
SMLZ13WBDDW(A)													(x, y) (0.34, 0.34)											

*1: Duty 1/10, 1kHz *2: Reference

Dimensions

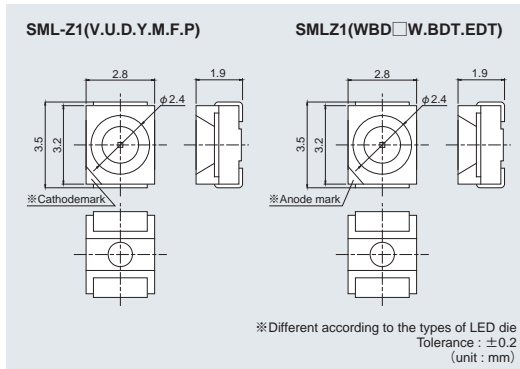

Recommended Solder Pattern Viewing Angle

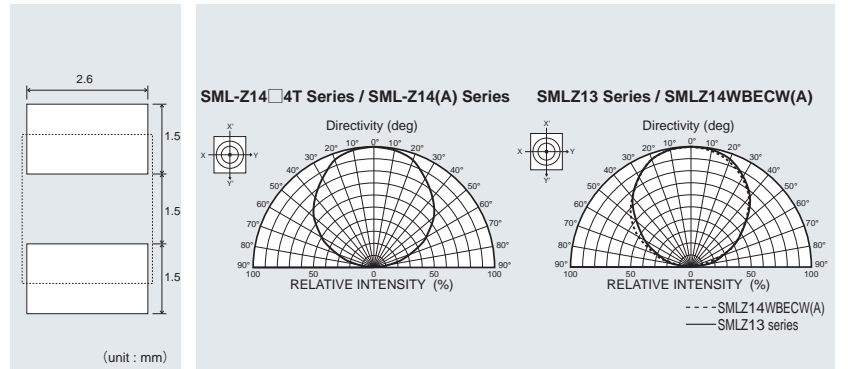

Electrical Characteristics Curves

Forward Current-Forward Voltage

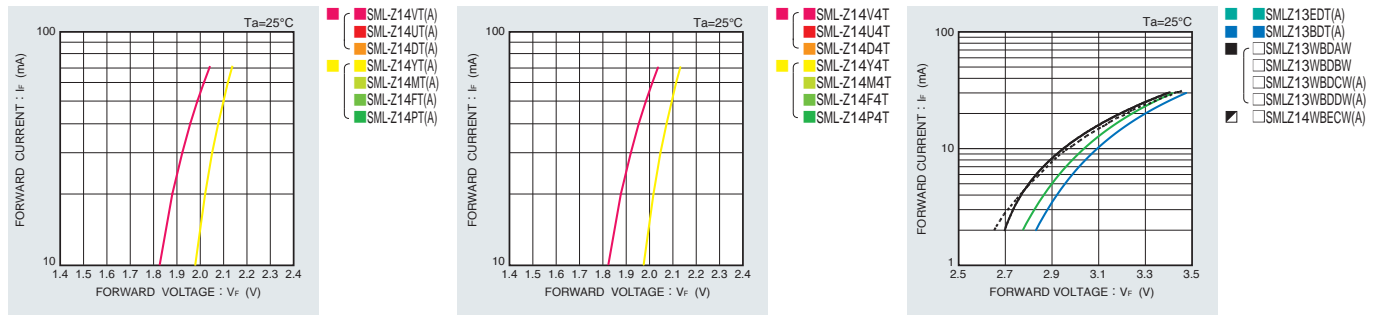

Luminous Intensity-Atmosphere Temperature

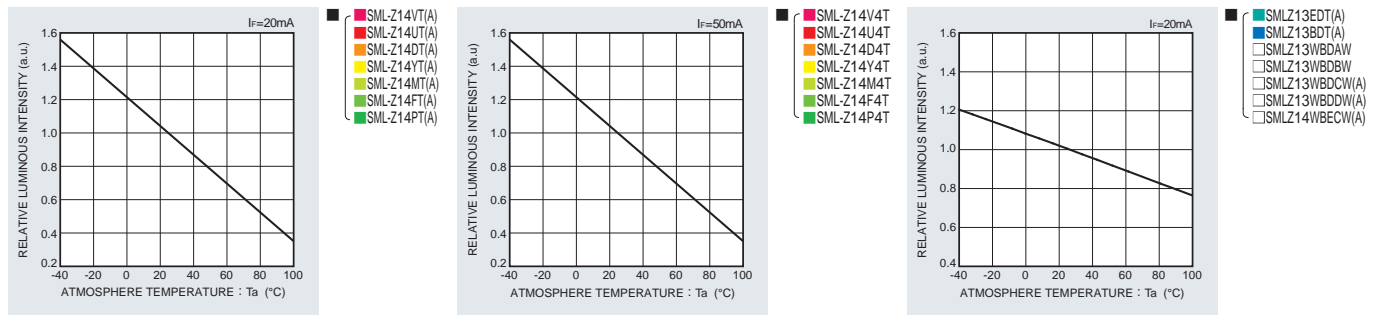

Luminous Intensity-Forward Current

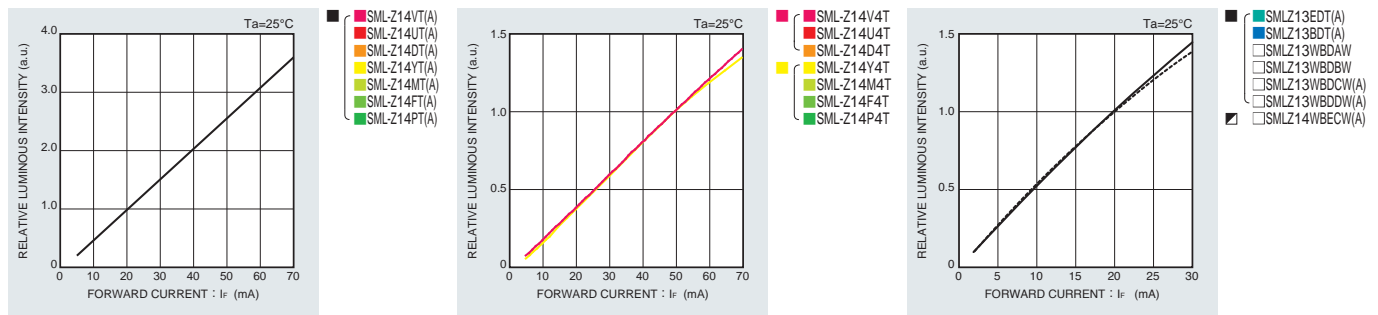

Derating

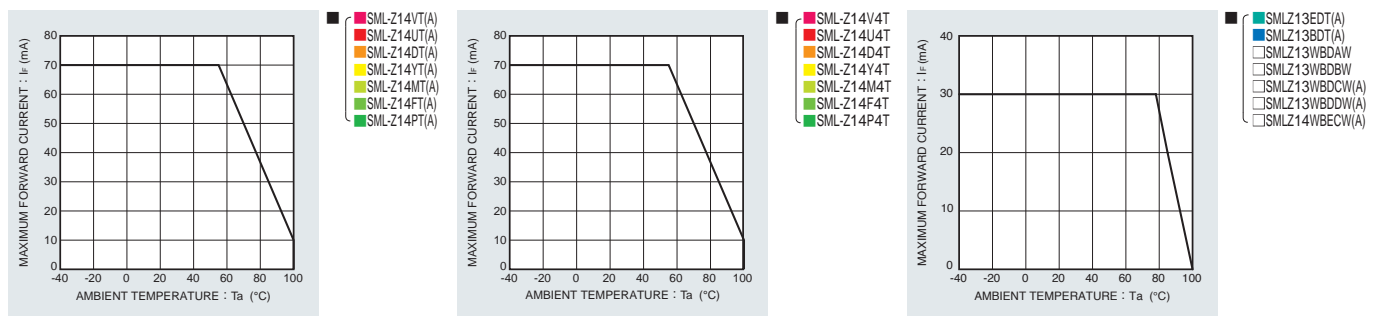

16115(0604) size PICOLED™ -side

SML-R1 Series



Actual Size
 16115(0604)
 1.6×1.15mm(t=0.2mm)

Features

- Ultra compact, thin side-view type LED
- Low height package t=0.2mm



Specifications

Part No.	Chip Structure	Emitting Color	Absolute Maximum Ratings (Ta=25°C)					Electrical and Optical Characteristics (Ta=25°C)											
			Power Dissipation Pd (mW)	Forward Current If (mA)	Peak Forward Current Ifp (mA)	Reverse Voltage Vr (V)	Operating Temperature Topr (°C)	Storage Temperature Tstg (°C)	Forward Voltage V _F		Reverse Current I _R		Dominant Wavelength λ _D			Luminous Intensity I _v			
							Typ. (V)	I _F (mA)	Max. (μA)	V _R (V)	Min.*2 (nm)	Typ. (nm)	Max.*2 (nm)	I _F (mA)	Min. (mcd)	Typ. (mcd)	I _F (mA)		
■ SML-R12V8T	AlGaInP on GaAs	Red	54	20	100*1	5	-40 to +85	-40 to +100	2.2	20	10	5	625	630	635	20	16	40	20
■ SML-R12U8T													615	620	625		25	63	
■ SML-R12D8T		Orange											602	605	608		40	100	
■ SML-R12Y8T													Yellow	587	590		593	25	
■ SML-R12M8T		Yellowish Green												569	572		575	10	
■ SML-R12P8T		Green											557	560	563		2.5	6.3	
■ SMLR13BDT	InGaN on SiC	Blue	66	20	100*1	5	-40 to +85	-40 to +100	3.0	5	10	5	465	470	475	5	14	36	5
□ SMLR13WBDW		White	78										(x, y) (0.30, 0.30)	56	110				

*1: Duty 1/10, 1kHz *2: Reference

Dimensions

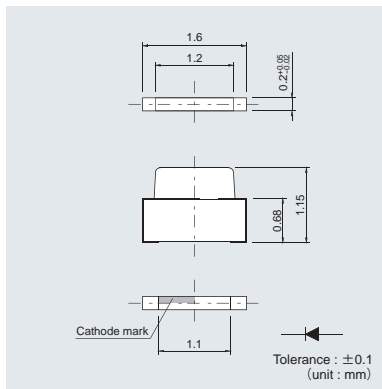

Recommended Solder Pattern Viewing Angle

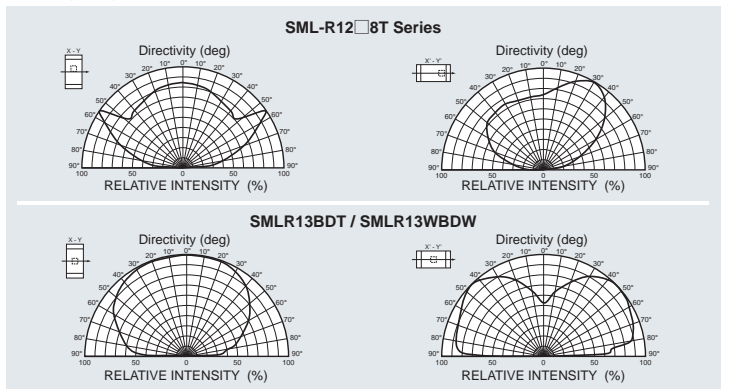
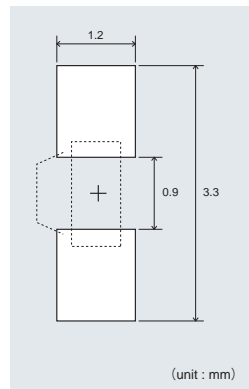

* PICOLED™ is ROHM's pending trademark.

Electrical Characteristics Curves

Forward Current-Forward Voltage

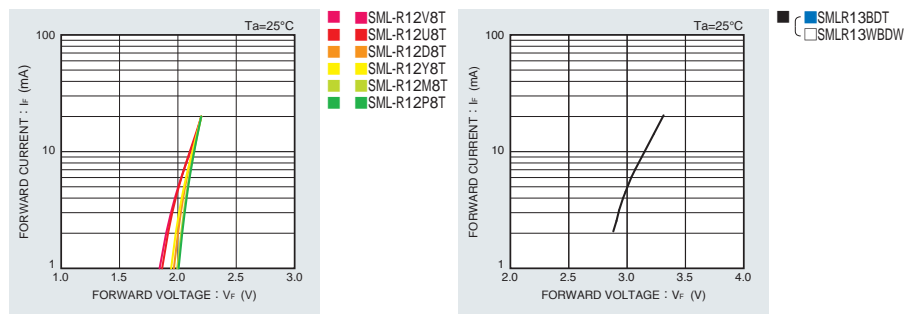

Luminous Intensity-Atmosphere Temperature

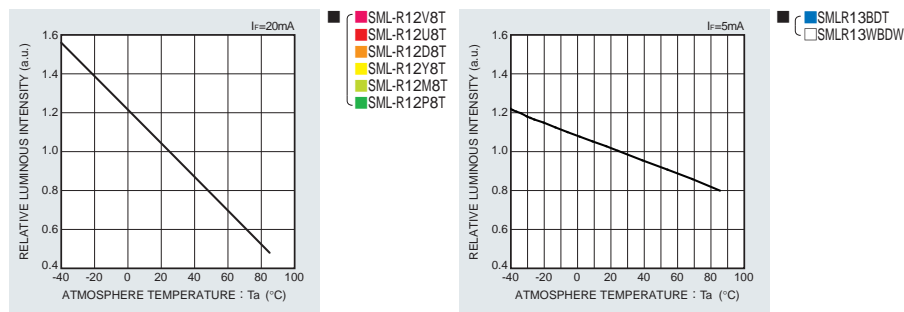

Luminous Intensity-Forward Current

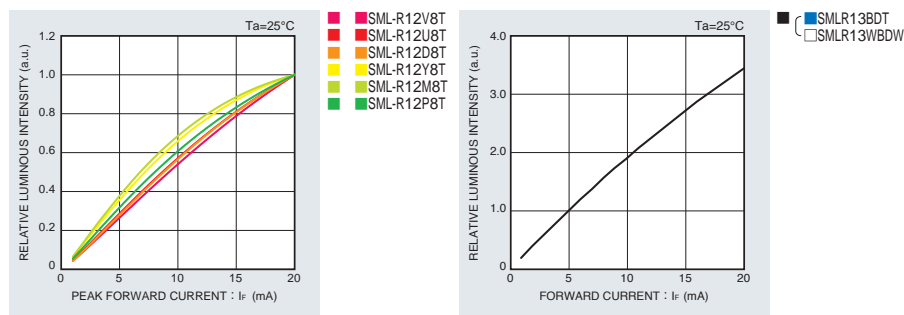

Derating

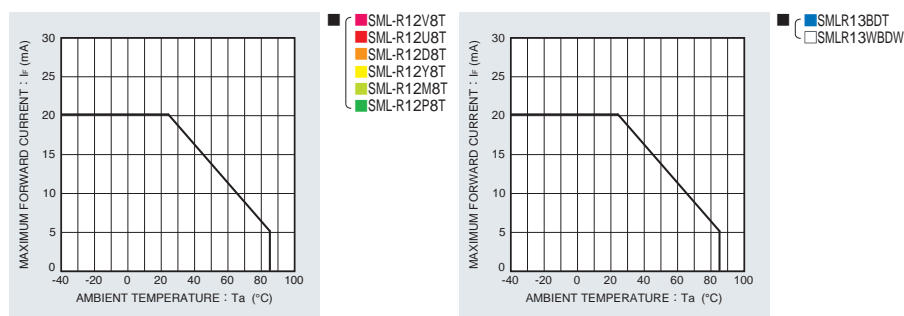

1611(0605) size

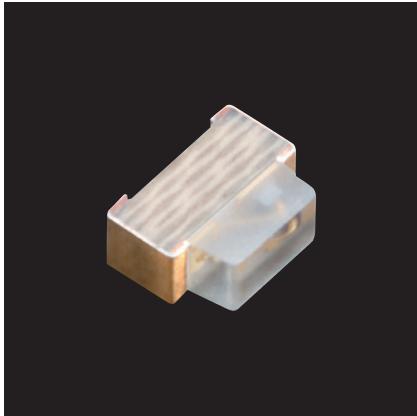

SML-A1 Series

Actual Size
 ⬢ 1611(0605)
 1.6×1.15mm(t=0.55mm)

Features

- Side-view type
- 1.6×1.15mm, t=0.55mm
- EXCELED™



Specifications

Part No.	Chip Structure	Emitting Color	Absolute Maximum Ratings (Ta=25°C)					Electrical and Optical Characteristics (Ta=25°C)													
			Power Dissipation Pd(mW)	Forward Current IF(mA)	Peak Forward Current I _{FP} (mA)	Reverse Voltage VR(V)	Operating Temperature Topr(°C)	Storage Temperature Tstg(°C)	Forward Voltage VF Typ.(V)	IF(mA)	Reverse Current IR Max.(μA)	VR(V)	Dominant Wavelength λ D Min.*2 Typ. Max.*2			Luminous Intensity Iv Min. Typ. IF(mA)					
■ SML-A12V8T	AlGaInP on GaAs	Red	54	20					2.2				625	630	635		16	40			
■ SML-A12U8T													615	620	625		25	63			
■ SML-A12UT(J)													619	624	629		36				
■ SML-A12D8T	AlGaInP on GaAs	Orange	54	20	100*1	5	-40 to +85	-40 to +100	2.2		10	5	602	605	608	20	40	100			
■ SML-A12DT(J)													606	609	36		20				
■ SML-A12WT(J)													587	590	593		25	63			
■ SML-A12Y8T	AlGaInP on GaAs	Yellow	54	20					2.2				569	572	575		10	25			
■ SML-A12M8T													567	570	573		14	40			
■ SML-A12MT(J)													557	560	563		2.5	6.3			
■ SML-A12P8T	AlGaInP on GaAs	Yellowish Green	54	20			-40 to +85	-40 to +100	2.2		10		557	560	563		2.5	6.3			
■ SMLA12BC7T													465	470	475		5	5.6		16	5
■ SMLA13BDT													464	476	20		56	140		20	
□ SMLA12WBC7W	InGaIn on SiC	White	66		100*1	5	-30 to +85	-40 to +100	2.9	5	100	5	(x, y) (0.30,0.30)			5	22	56	5		
□ SMLA13WBDW													3.1	10	10	90	180	10			

*1:Duty1/10, 1kHz *2:Reference

Dimensions

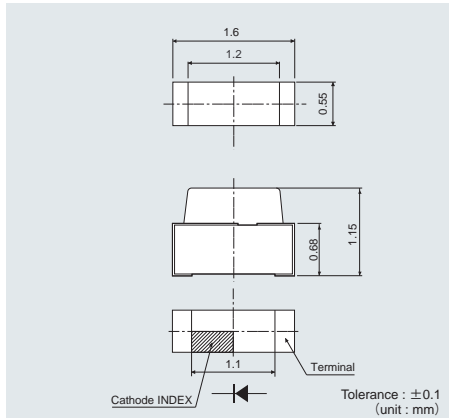

Recommended Solder Pattern Viewing Angle

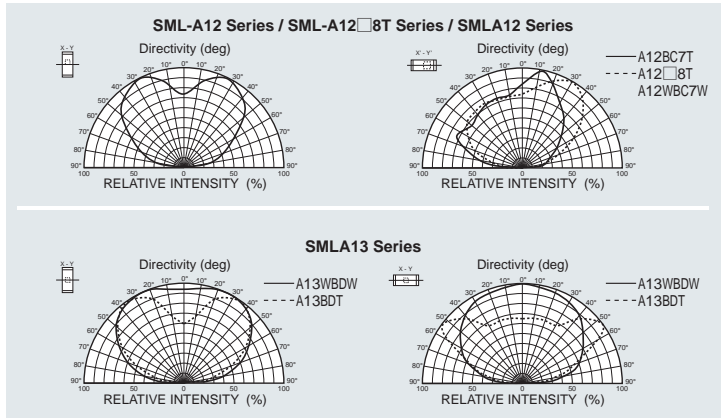
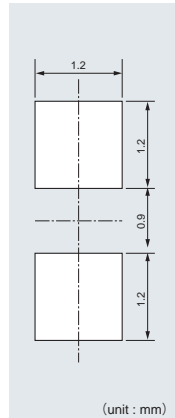

*EXCELED™ is ROHM's pending trademark.

Electrical Characteristics Curves

Forward Current-Forward Voltage

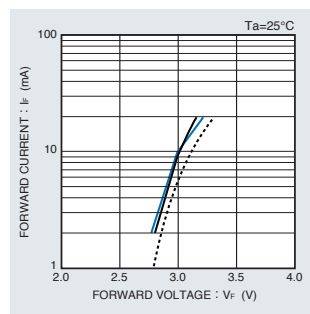
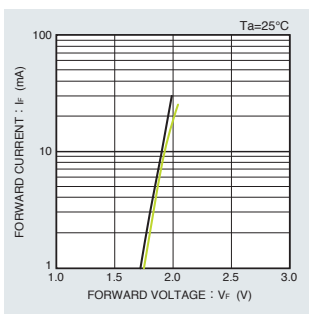
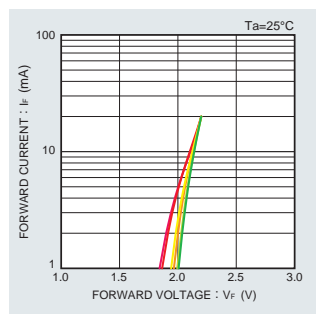

Luminous Intensity-Atmosphere Temperature

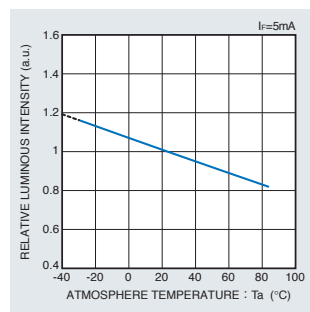
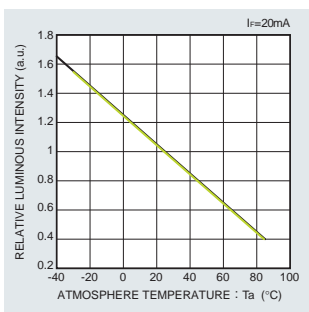
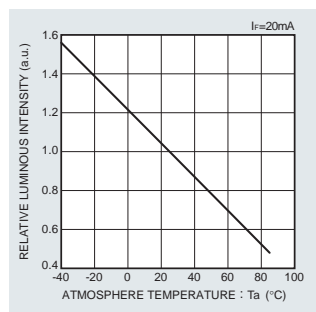

Luminous Intensity-Forward Current

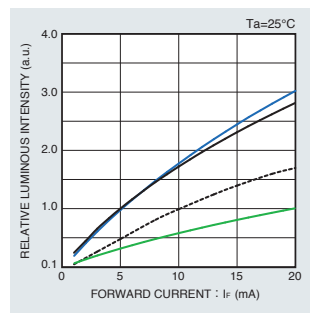
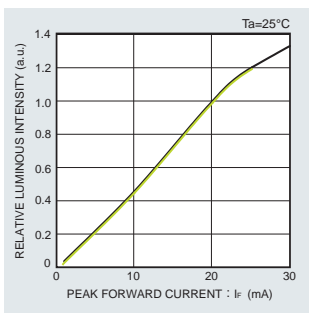
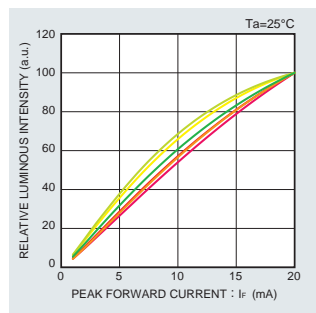

Derating

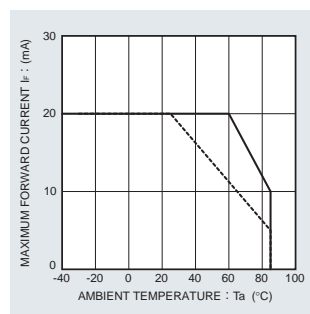
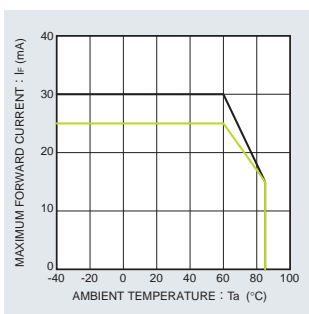
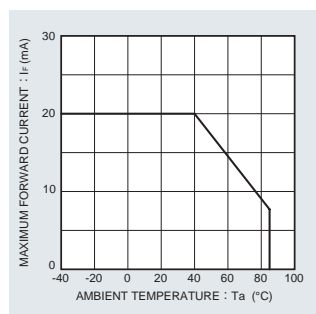

1810(0704) size

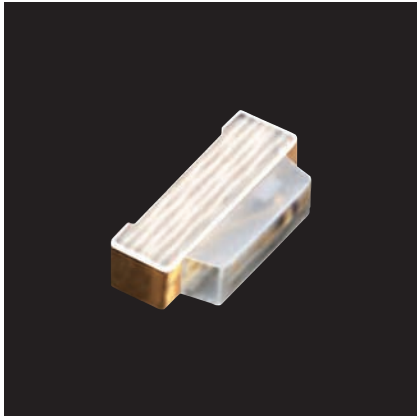

SMLF1 Series

Actual Size
 1810(0704)
 1.8×1.0mm(t=0.35mm)

- Features**
- Thin, side-view package

Color Type WB

Specifications

Part No.	Chip Structure	Emitting Color	Absolute Maximum Ratings (Ta=25°C)						Electrical and Optical Characteristics (Ta=25°C)								
			Power Dissipation Pd(mW)	Forward Current IF(mA)	Peak Forward Current I _{FP} (mA)	Reverse Voltage VR(V)	Operating Temperature Topr(°C)	Storage Temperature Tstg(°C)	Forward Voltage VF Typ.(V)	IF(mA)	Reverse Current IR Max.(μA)	VR(V)	Chromaticity Coordinates (x, y)	IF(mA)	Luminous Intensity Iv Min.(mcd)	Typ.(mcd)	IF(mA)
□ SMLF13WBDW	InGaN on SiC	White	74	20	100*	5	-40 to +85	-40 to +100	2.9	5	10	5	(x, y) (0.29,0.28)	5	36	90	5

*:Duty1/10, 1kHz

Dimensions

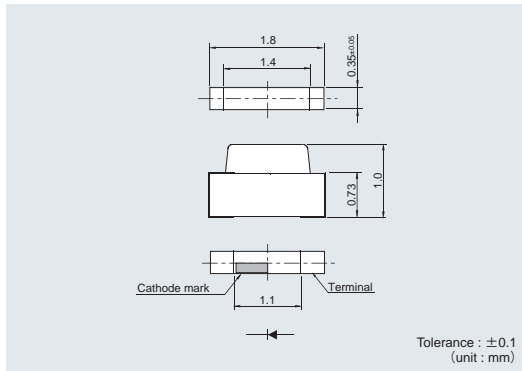

Recommended Solder Pattern

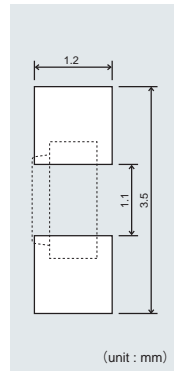

Viewing Angle

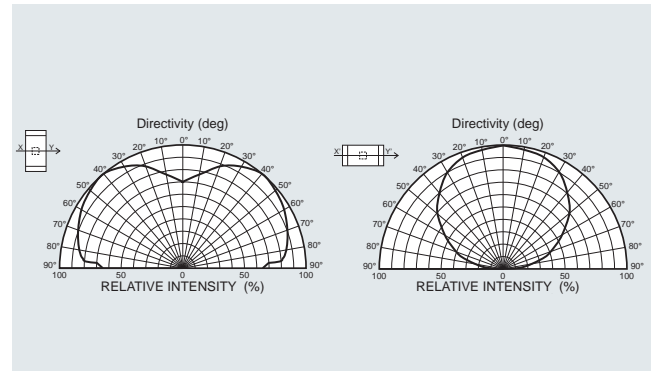

Electrical Characteristics Curves

Forward Current-Forward Voltage

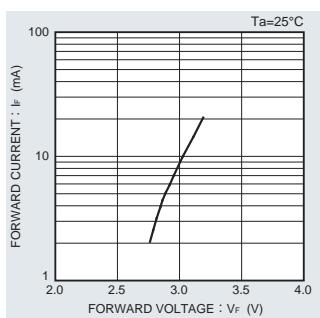

■ □ SMLF13WBDW

Luminous Intensity-Atmosphere Temperature

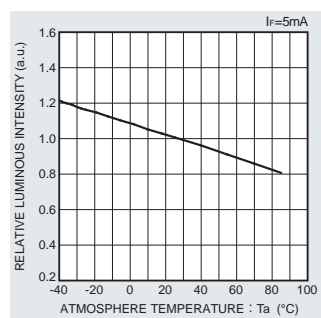

■ □ SMLF13WBDW

Luminous Intensity-Forward Current

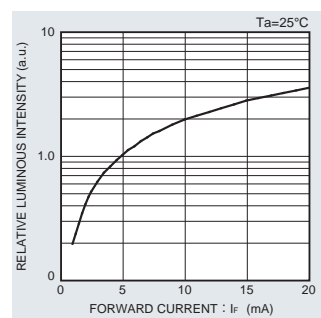

■ □ SMLF13WBDW

Derating

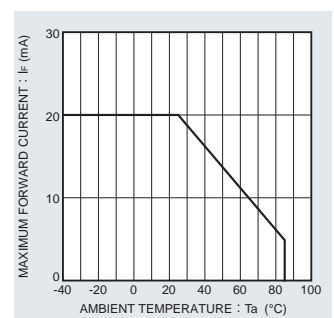

■ □ SMLF13WBDW

3810(1504) size

SMLC1 Series



Actual Size
 3810(1504)
 3.8×1.0mm(t=0.6mm)

Features

- Side-view with reflector type
- High luminous intensity

Color Type WB

Specifications

Part No.	Chip Structure	Emitting Color	Absolute Maximum Ratings (Ta=25°C)						Electrical and Optical Characteristics (Ta=25°C)								
			Power Dissipation Pd(mW)	Forward Current IF(mA)	Peak Forward Current I _{FP} (mA)	Reverse Voltage VR(V)	Operating Temperature Topr(°C)	Storage Temperature Tstg(°C)	Forward Voltage VF Typ.(V)	IF(mA)	Reverse Current IR Max.(μA)	VR(V)	Chromaticity Coordinates (x, y)	IF(mA)	Luminous Intensity I _v Min.(mcd)	Typ.(mcd)	IF(mA)
<input type="checkbox"/> SMLC14WBEPW	InGaN on Sic	White	120	30	100*	5	-30 to +85	-30 to +100	3.2	20	50	5	(x, y) (0.30,0.29)	20	1,440	1,800	20

*:Duty1/10, 1kHz

Dimensions

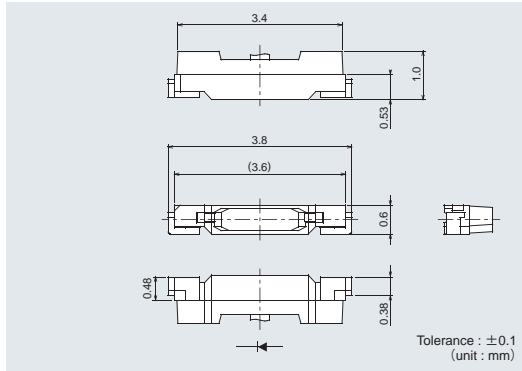

Recommended Solder Pattern Viewing Angle

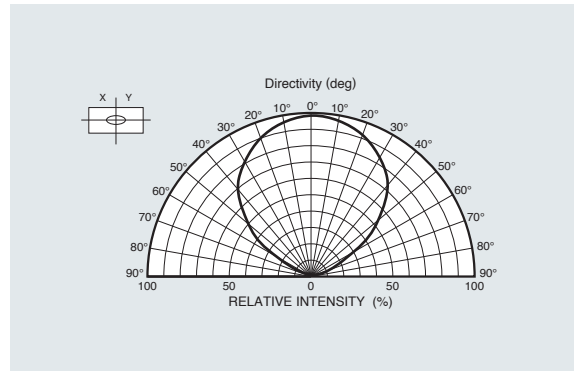
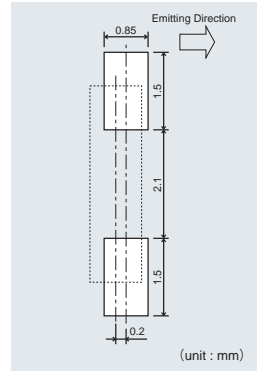

Electrical Characteristics Curves

Forward Current-Forward Voltage

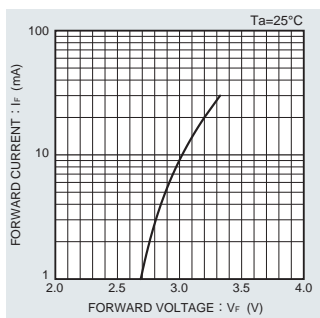

SMLC14WBEPW

Luminous Intensity-Atmosphere Temperature

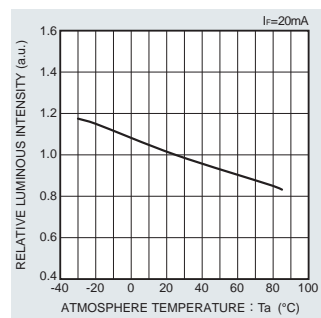

SMLC14WBEPW

Luminous Intensity-Forward Current

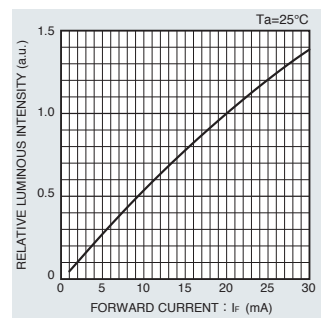

SMLC14WBEPW

Derating

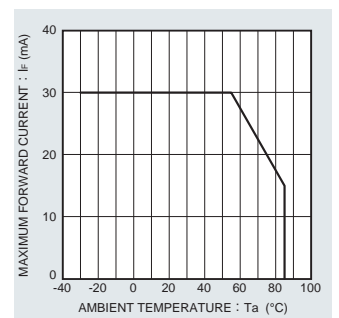

SMLC14WBEPW

3020(1208) size



SML-11 Series

Actual Size
 3020(1208)
 3.0×2.0mm(t=1.6mm)

Features

- Side-view with reflector type
- 3.0×2.0mm, t=1.6mm

Color Type	L	V	D	Y
	M	F	P	W

Specifications

Part No.	Chip Structure	Emitting Color	Absolute Maximum Ratings (Ta=25°C)					Electrical and Optical Characteristics (Ta=25°C)									
			Power Dissipation Pd(mW)	Forward Current IF(mA)	Peak Forward Current I _{FP} (mA)	Reverse Voltage VR(V)	Operating Temperature Topr(°C)	Storage Temperature Tstg(°C)	Forward Voltage VF		Reverse Current IR		Dominant Wavelength λ D			Luminous Intensity Iv	
							Typ.(V)	IF(mA)	Max.(μA)	VR(V)	Min.*2 (nm)	Typ.*2 (nm)	Max.*2 (nm)	IF(mA)	Min. (mcd)	Typ. (mcd)	IF(mA)
SML-110VT	GaAsP on GaP	Red									625	630	635		2.2	6.3	
SML-110DT		Orange						2				602	605	608		3.6	10
SML-110YT	GaP	Yellow	70	25	60*1	4	-30 to +85	-40 to +85			587	590	593	20	2.2	6.3	20
SML-110MT		Yellowish Green															
SML-110FT	GaP	Green									562	565	568		3.6	10	
SML-110PT		Green										557	560	563		2.2	6.3

*1:Duty1/5, 200Hz *2:Reference

Dimensions

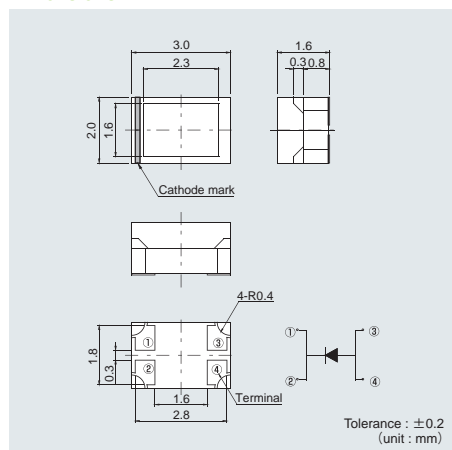

Recommended Solder Pattern Viewing Angle

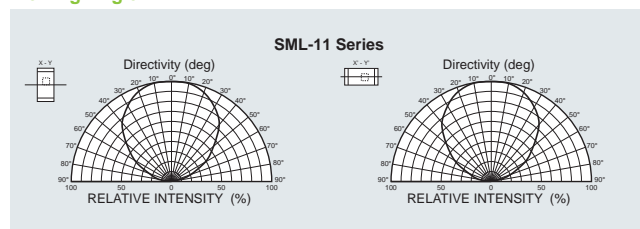
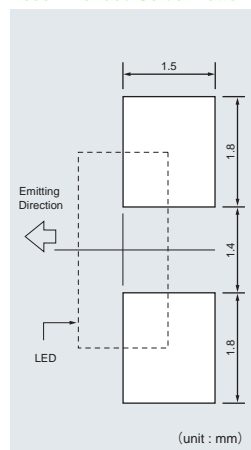

Electrical Characteristics Curves

Forward Current-Forward Voltage

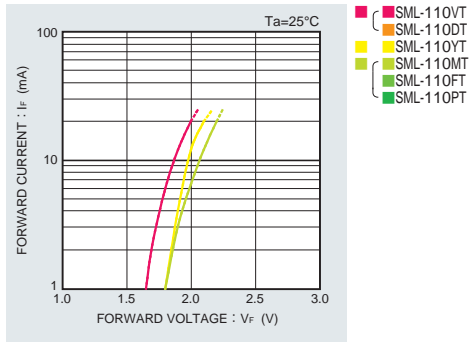

Luminous Intensity-Atmosphere Temperature

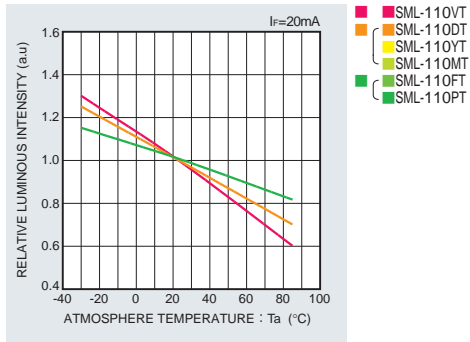

Luminous Intensity-Forward Current

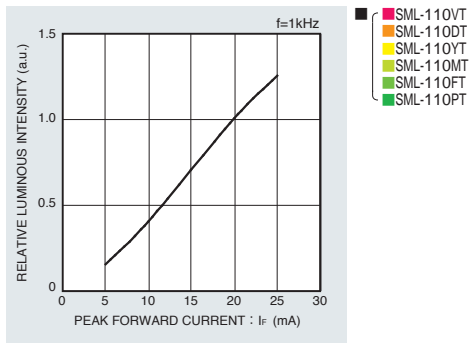

Derating

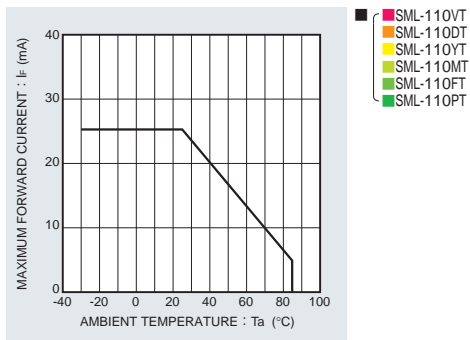

3412(1305) size

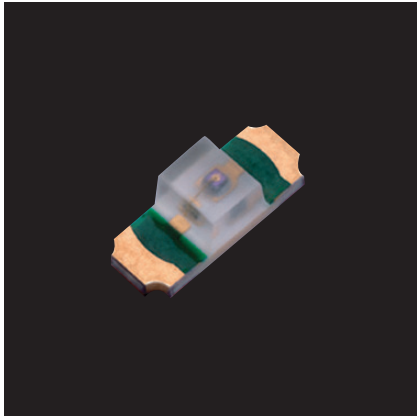

SML-81 Series

Actual Size
 3412(1305)
 3.4×1.25mm(t=1.1mm)

Features

- Reverse-mount type

Color Type **U** **D** **W** **M** **B**

Specifications

Part No.	Chip Structure	Emitting Color	Absolute Maximum Ratings (Ta=25°C)					Electrical and Optical Characteristics (Ta=25°C)											
			Power Dissipation Pd(mW)	Forward Current IF(mA)	Peak Forward Current I _{FP} (mA)	Reverse Voltage VR(V)	Operating Temperature Topr(°C)	Storage Temperature Tstg(°C)	Forward Voltage VF		Reverse Current IR		Dominant Wavelength λD			Luminous Intensity Iv			
								Typ.(V)	IF(mA)	Max.(μA)	VR(V)	Min.*3 (nm)	Typ.*3 (nm)	Max.*3 (nm)	IF(mA)	Min. (mcd)	Typ. (mcd)	IF(mA)	
SML-811UT(A)	AlGaInP on GaAs	Red										615	620	625		11.2	22.4	10	
SML-811DT(A)		Orange	62		100*2	5	-40 to +85	-40 to +100	1.95	10		5	602	605	608	10			
SML-811WT(A)		Yellow	25								100		587	590	593		28		
SML-812MT	GaP	Yellowish Green			60*1	4	-30 to +85	-40 to +85	2.1			4	569	572	575		14	40	
SML-810MT				65					2.2	20			4	567	570	573	20	5.6	16
SML812BCT	InGaN on SiC	Blue	80	20	100*2	5					5	464	470	476		22	56		

* 1: Duty 1/5, 200Hz * 2: Duty 1/10, 1kHz * 3: Reference

Dimensions

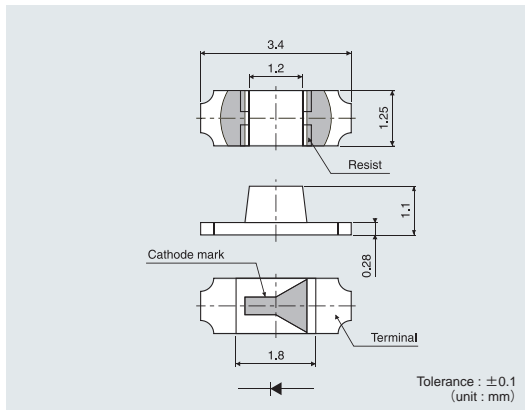

Recommended Solder Pattern

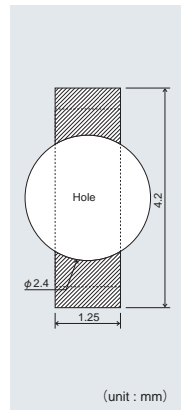

Viewing Angle

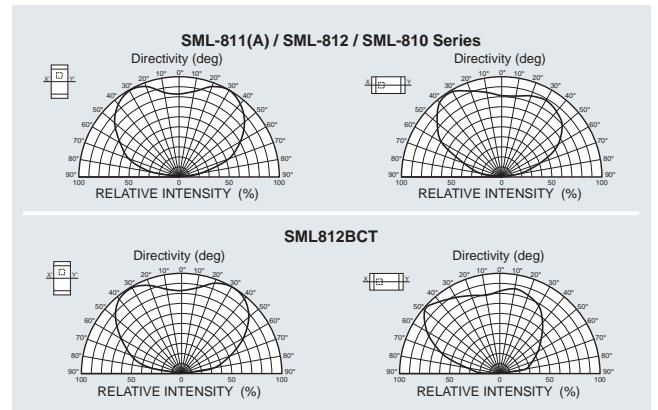

Electrical Characteristics Curves

Forward Current-Forward Voltage

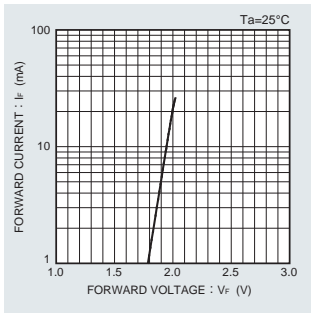

■ SML-811UT(A)
■ SML-811DT(A)
■ SML-811WT(A)

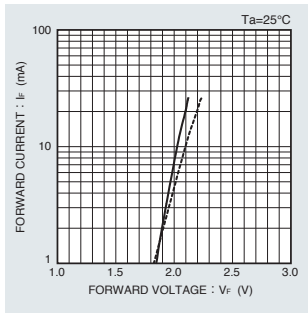

■ SML-812MT
■ SML-810MT

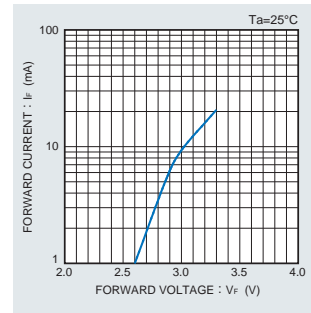

■ SML812BCT

Luminous Intensity-Atmosphere Temperature

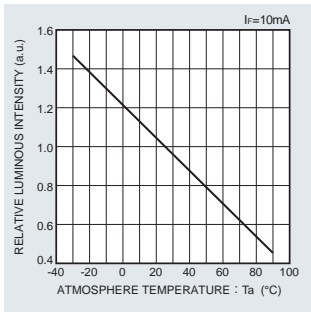

■ SML-811UT(A)
■ SML-811DT(A)
■ SML-811WT(A)

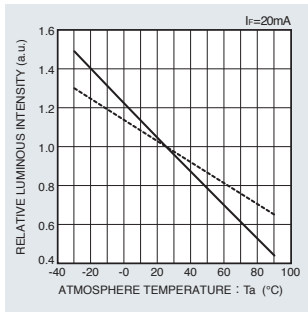

■ SML-812MT
■ SML-810MT

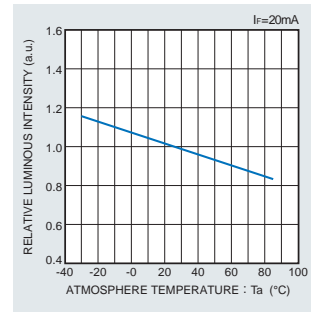

■ SML812BCT

Luminous Intensity-Forward Current

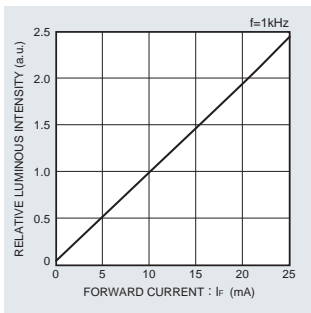

■ SML-811UT(A)
■ SML-811DT(A)
■ SML-811WT(A)

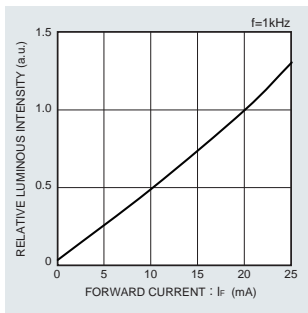

■ SML-812MT
■ SML-810MT

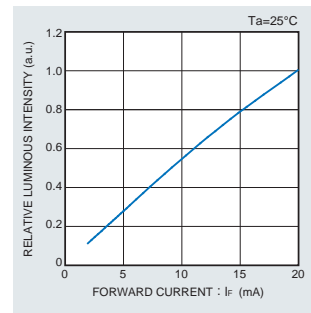

■ SML812BCT

Derating

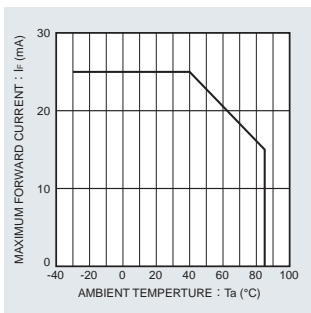

■ SML-811UT(A)
■ SML-811DT(A)
■ SML-811WT(A)

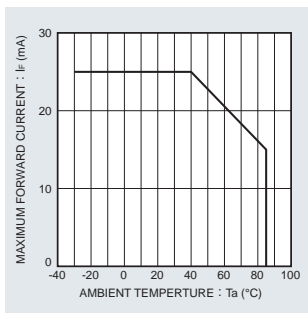

■ SML-812MT
■ SML-810MT

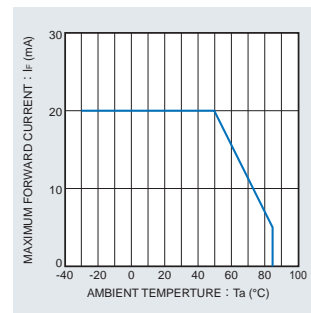

■ SML812BCT

Lens type LEDs

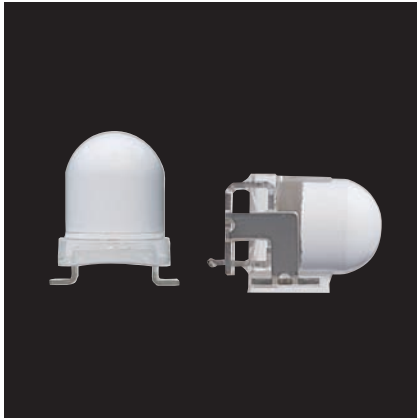

SML-L1 / SML-J1 series

SML-J1

Actual Size
 4034(1613)
 4.0×3.4mm (t=4.55mm)

SML-L1

Actual Size
 3649(1419)
 3.6×4.9mm (t=3.3mm)

Features

- High power, high brightness, surface mount type LEDs with Lens.
- The SML-L1 series represents the first side view lens LEDs in the industry.
- A top view model (SML-J1) is featuring a package height of the only 4.5mm - the smallest on the planet.
- A directivity of 8° is possible by optimizing the lens and frame structures. The light axis is also minimized to ±3°.

*ROHM Jan. 2010 Survey.

Color Type D R

Specifications

Part No.	Chip Structure	Emitting Color	Absolute Maximum Ratings (Ta=25°C)						Electrical and Optical Characteristics (Ta=25°C)										
			Power Dissipation Pd(mW)	Forward Current If(mA)	Peak Forward Current Ifp(mA)	Reverse Voltage Vr(V)	Operating Temperature Topr(°C)	Storage Temperature Tstg(°C)	Forward Voltage V _F Typ.(V)	Forward Current If(mA)	Reverse Current I _R Max.(μA)	Reverse Voltage V _R (V)	Dominant Wavelength λ D			Luminous Intensity I _v			
■ SML-L13DT	AlGaInP on GaAs	Orange	175	70	200	10	-40 to +85	-40 to +100	2.0	20	100	5	598	605	612	20	10	15	
■ SML-L14DT													-	610	-	20	22	20	
■ SML-J14DT													-	-	-	20	28		

Part No.	Chip Structure	Emitting Color	Absolute Maximum Ratings (Ta=25°C)						Electrical and Optical Characteristics (Ta=25°C)										
			Power Dissipation Pd(mW)	Forward Current If(mA)	Peak Forward Current Ifp(mA)	Reverse Voltage Vr(V)	Operating Temperature Topr(°C)	Storage Temperature Tstg(°C)	Forward Voltage V _F Typ.(V)	Forward Current If(mA)	Reverse Current I _R Max.(μA)	Reverse Voltage V _R (V)	Dominant Wavelength λ D			Radiation Intensity I _e			
□ SML-J14RT	AlGaInP on GaAs	Infrared LED	247	130	500	5	-40 to +85	-40 to +100	1.65	50	100	5	-	870	-	50	50	75	50

Dimensions

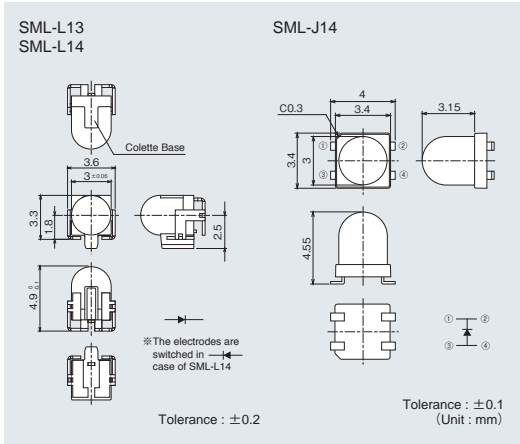

Recommended Solder Pattern

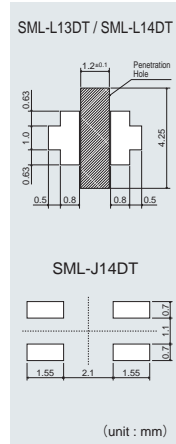

Viewing Angle

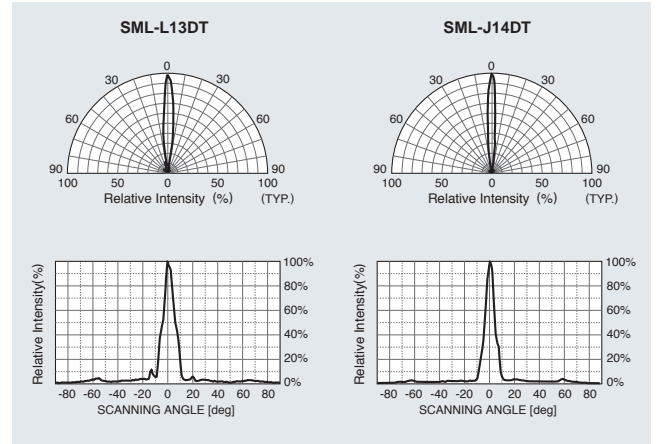

Electrical Characteristics Curves

Forward Current-Forward Voltage

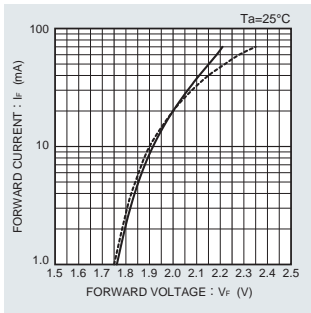

■ SML-L13DT
▨ SML-L14DT

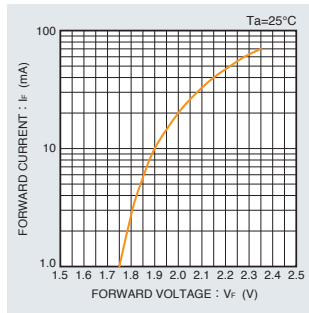

■ SML-J14DT

Luminous Intensity-Atmosphere Temperature

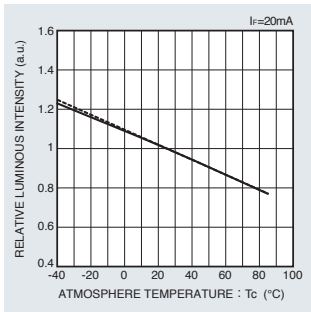

■ SML-L13DT
▨ SML-L14DT

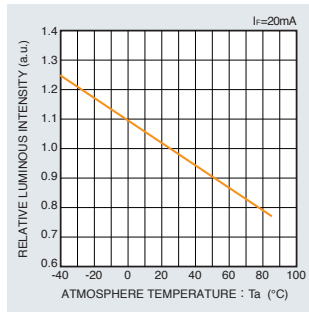

■ SML-J14DT

Luminous Intensity-Forward Current

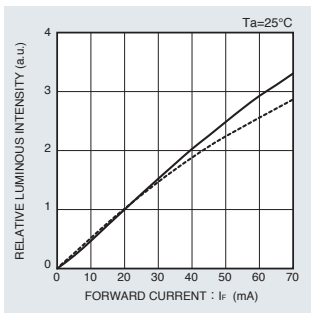

■ SML-L13DT
▨ SML-L14DT

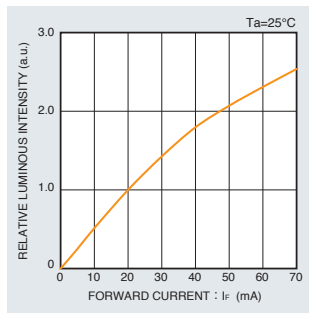

■ SML-J14DT

Derating

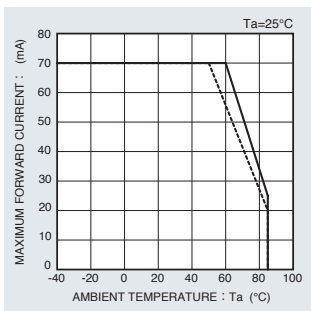

■ SML-L13DT
▨ SML-L14DT

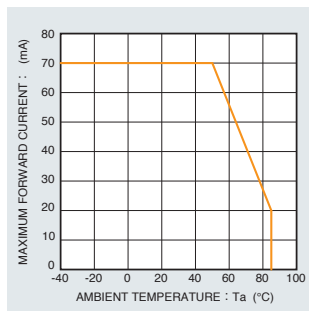

■ SML-J14DT

1010(0404) size PICOLED™ -Duo

SML-P24 Series

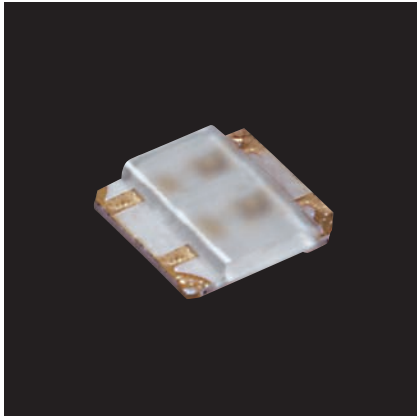

Actual Size
 ◆ 1010(0404)
 1.0×1.0mm(t=0.2mm)

Features

- Ultra compact 2-color type LED 1.0×1.0mm
- Thinnest in the world* t=0.2mm
- Low height contributes to the improvement of color mixture

* Investigated Aug. 2009



Specifications

Part No.	Chip Structure	Emitting Color	Absolute Maximum Ratings (Ta=25°C)						Electrical and Optical Characteristics (Ta=25°C)										
			Power Dissipation Pd(mW)	Forward Current IF(mA)	Peak Forward Current IFP(mA)	Reverse Voltage VR(V)	Operating Temperature Topr(°C)	Storage Temperature Tstg(°C)	Forward Voltage VF		Reverse Current IR		Dominant Wavelength λ D			Luminous Intensity Iv			
								Typ.(V)	IF(mA)	Max.(μA)	VR(V)	Min.*2 (nm)	Typ.*2 (nm)	Max.*2 (nm)	IF(mA)	Min. (mcd)	Typ. (mcd)	IF(mA)	
SML-P24MUW	AlGaInP on GaAs	Green	54	20	100*1	5	-40 to +85	-40 to +100	2.2	20	100	4	569	572	575	20	10	21	20
		Red	52						2.1				615	620	625		25	52	

* 1:Duty 1/10, 1kHz * 2:Reference

Dimensions

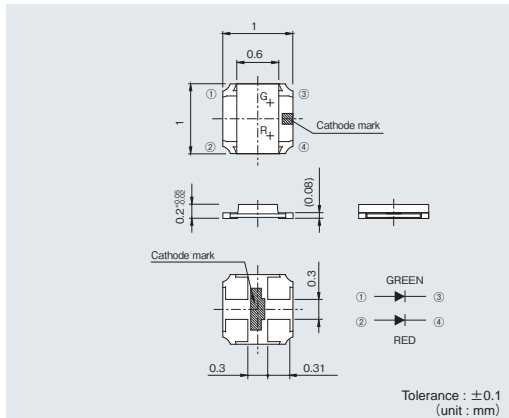

Recommended Solder Pattern

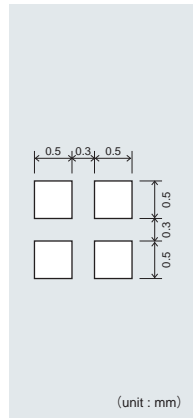

Viewing Angle

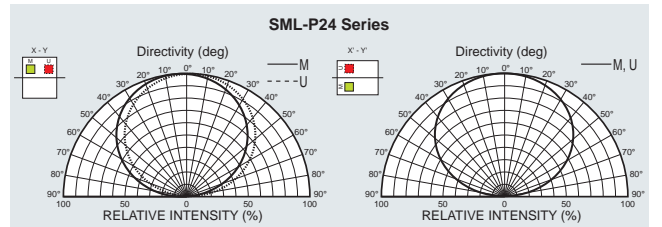

Electrical Characteristics Curves

Forward Current-Forward Voltage

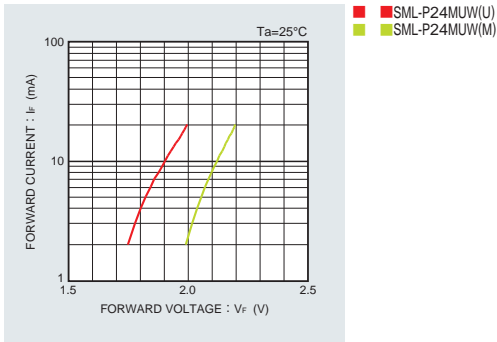

Luminous Intensity-Atmosphere Temperature

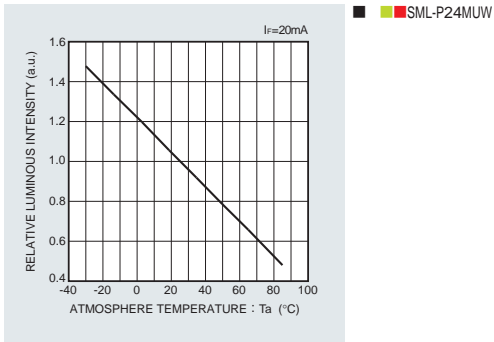

Luminous Intensity-Forward Current

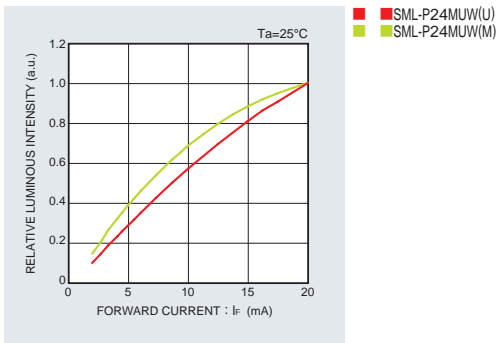

Derating

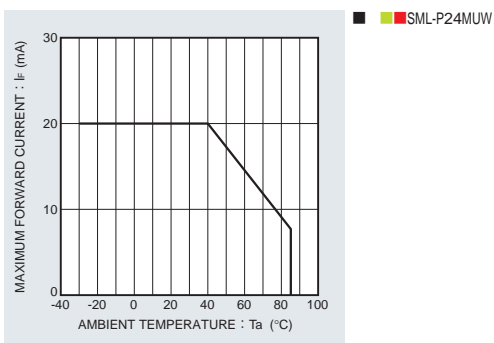

1315(0506) size

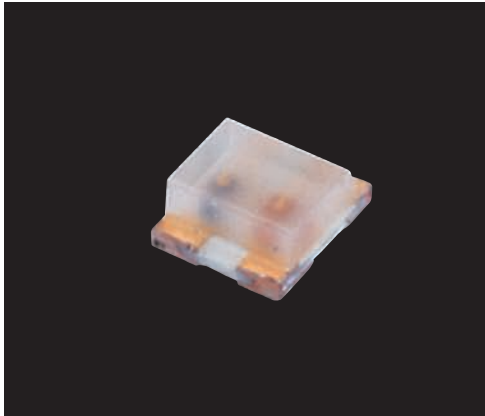

SML-52 Series

Actual Size
 1315(0605)
 1.3 × 1.5mm (t=0.6mm)

Features

- 2-color type LED
- Abundant 2 color variations



Specifications

Part No.	Chip Structure	Emitting Color	Absolute Maximum Ratings (Ta=25°C)						Electrical and Optical Characteristics (Ta=25°C)										
			Power Dissipation Pd (mW)	Forward Current If (mA)	Peak Forward Current I _{FP} (mA)	Reverse Voltage V _R (V)	Operating Temperature Topr (°C)	Storage Temperature Tstg (°C)	Forward Voltage V _F Typ. (V)	Forward Current I _F (mA)	Reverse Current I _R Max. (μA)	Reverse Voltage V _R (V)	Dominant Wavelength λ _D (nm)			Luminous Intensity I _v (mcd)			
SML522BUW	InGaN on SiC	Blue	66	20	60*2	5	-40 to +85	-40 to +100	2.9	5	10	5	465	470	475	5	9.0	22	5
	AlGaInP on GaAs	Red	50						1.9				619	624	629		10	21	
SML-522MUW	AlGaInP on GaAs	Yellowish Green	52	20	60*1				2.1				569	572	575		14	40	
		Red	50						1.9				615	620	625		22	63	
SML-522MU8W	AlGaInP on GaAs	Green	52	20	60*2	4	-30 to +85	-40 to +100	2.2	100			569	572	575		16	40	
		Red	52						2.2				615	620	625		25	63	
SML-521MUW	AlGaInP on GaAs Gap	Yellowish Green	70	25	60*1				2.2	20	4		569	572	575	20	5.6	16	20
		Red	50						1.9				615	620	625		22	63	
SML-522MD8W	AlGaInP on GaAs	Green	52	20	100*2	5	-40 to +85	-40 to +100	2.1	10			569	572	575		10	18	
		Orange	52						2.1				602	605	608		40	63	
SML-521MDW	AlGaInP on GaAs Gap	Yellowish Green	70	25	60*1	4	-30 to +85	-40 to +85	2.2	100			569	572	575		5.6	16	
		Orange	50						1.9				602	605	608		22	63	
SML-521MYW		Yellowish Green	70	25	60*1	4	-30 to +85	-40 to +85	2.2				569	572	575		5.6	16	
		Yellow	50	20					1.9				584	587	590		22	63	

*1:Duty1/5, 200Hz *2:Duty1/10, 1kHz *3:R:Reference

Dimensions

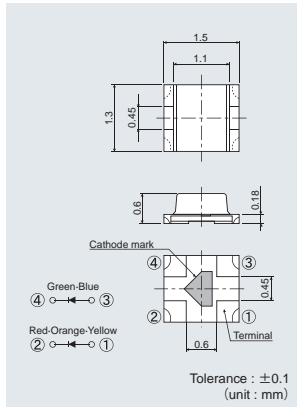

Recommended Solder Pattern

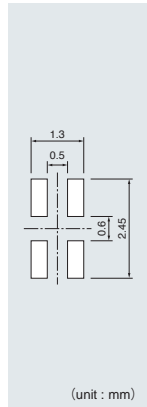

Viewing Angle

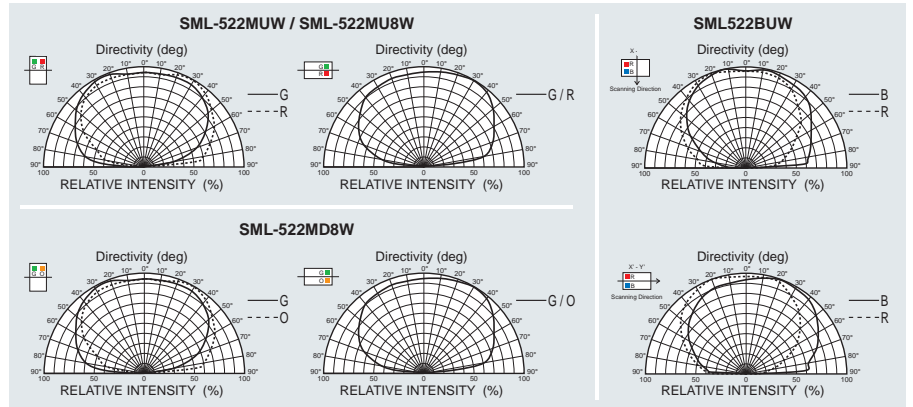

Electrical Characteristics Curves

Forward Current-Forward Voltage

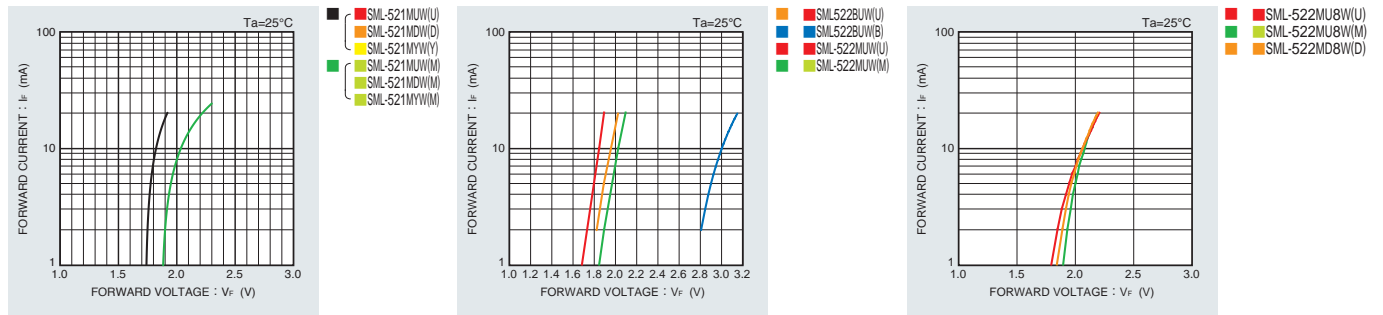

Luminous Intensity-Atmosphere Temperature

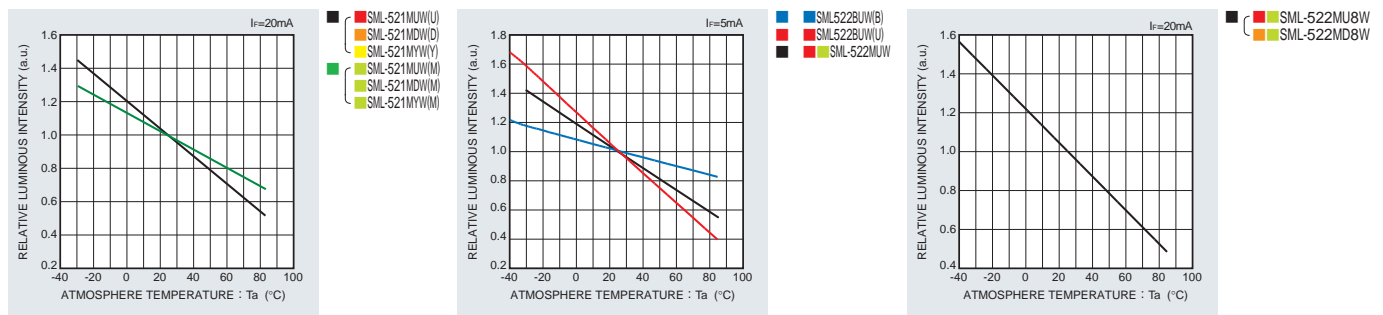

Luminous Intensity-Forward Current

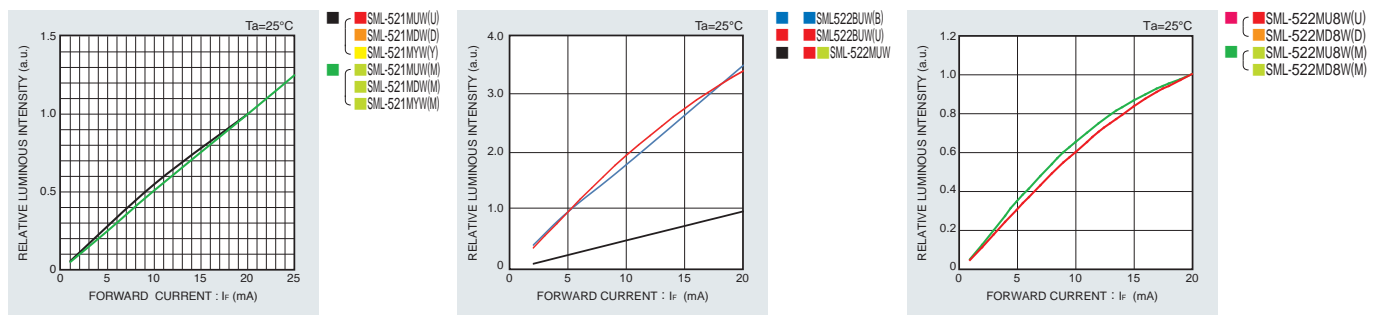

Derating

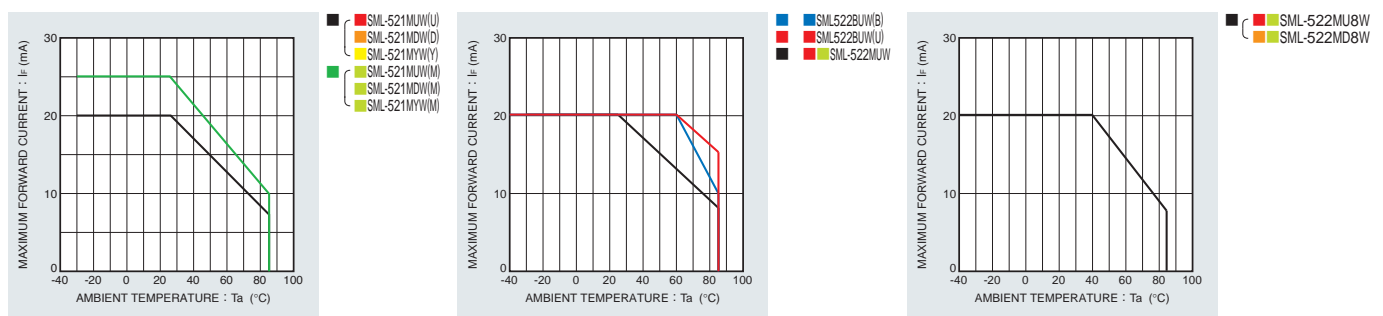

3025(1210) size

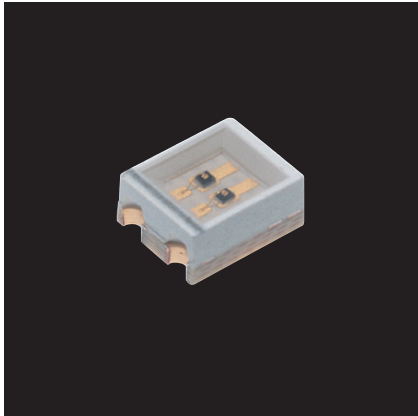

SML-02 Series

Actual Size
 3025(1210)
 3.0×2.5mm(t=1.3mm)

Features

•2-color type with reflector (standard)



Specifications

Part No.	Chip Structure	Emitting Color	Absolute Maximum Ratings (Ta=25°C)						Electrical and Optical Characteristics (Ta=25°C)									
			Power Dissipation Pd (mW)	Forward Current IF (mA)	Peak Forward Current IFP (mA)	Reverse Voltage VR (V)	Operating Temperature Topr (°C)	Storage Temperature Tstg (°C)	Forward Voltage VF Typ. (V)	IF (mA)	Reverse Current IR Max. (μA)	VR (V)	Dominant Wavelength λ D			Luminous Intensity Iv		
												Min.*3 (nm)	Typ.*3 (nm)	Max.*3 (nm)	IF (mA)	Min. (mcd)	Typ. (mcd)	IF (mA)
■ ■ SML022BUT	InGaN on SiC	Blue	120	30	80*2	5		-40 to +100	3.2		5	464	470	476		56	140	
	AlGaInP on GaAs	Red	75						2			619	624	629		90	220	
■ ■ SML-020MVT	GaAsP on GaAs	Green	60	25	60*1		-30 to +85	-40 to +85	2.2	20	100	20	569	572	575	9	20	20
		Red							2				625	630	635	3.6	6.3	
■ ■ SML-022ML8T	AlGaInP on GaAs	Green	52	20	60*2			-40 to +100	2.1				569	572	575	16	40	
		Red												630	635	640	10	

* 1:Duty1/5, 200Hz * 2:Duty1/10, 1kHz * 3:Reference

Dimensions

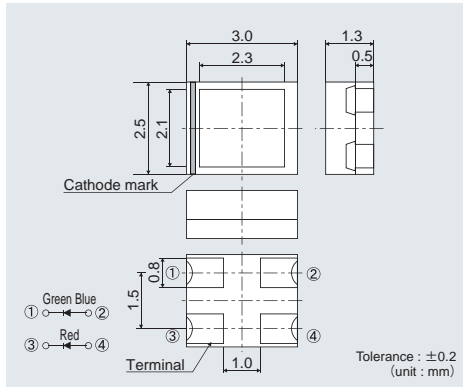

Recommended Solder Pattern Viewing Angle

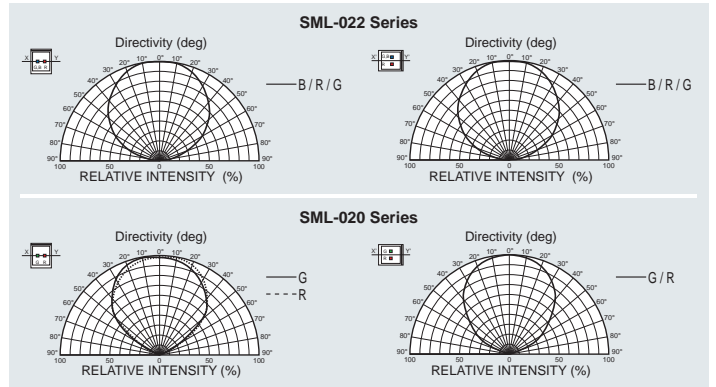
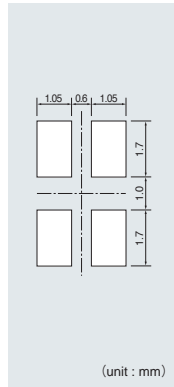

Electrical Characteristics Curves

Forward Current-Forward Voltage

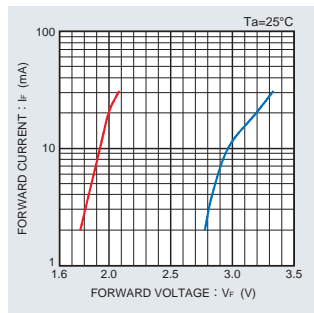

■ SML022BUT(U)
■ SML022BUT(B)

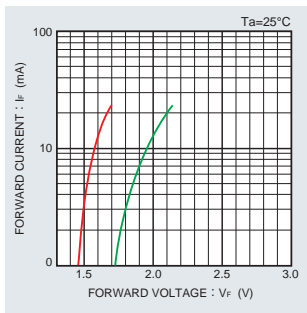

■ SML-020MVT(V)
■ SML-020MVT(M)

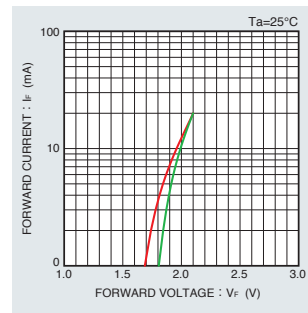

■ SML-022ML8T(L)
■ SML-022ML8T(M)

Luminous Intensity-Atmosphere Temperature

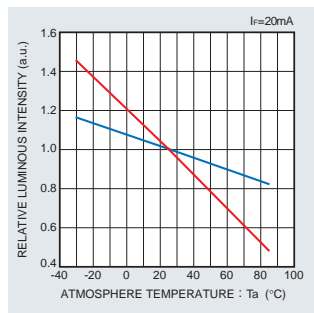

■ SML022BUT(U)
■ SML022BUT(B)

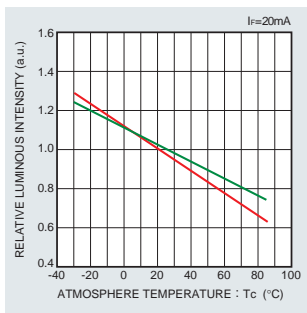

■ SML-020MVT(V)
■ SML-020MVT(M)

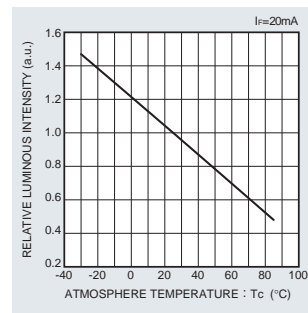

■ SML-022ML8T

Luminous Intensity-Forward Current

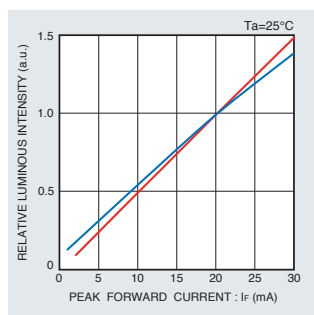

■ SML022BUT(U)
■ SML022BUT(B)

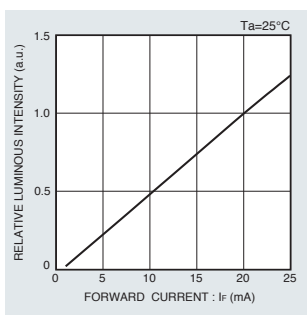

■ SML-020MVT(V)
■ SML-020MVT(M)

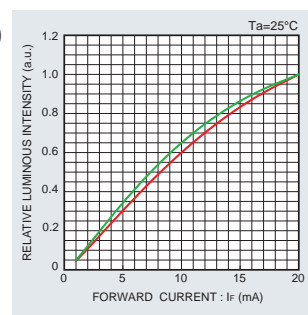

■ SML-022ML8T(L)
■ SML-022ML8T(M)

Derating

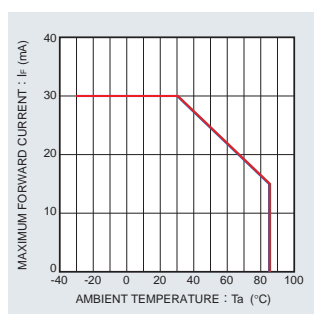

■ SML022BUT(U)
■ SML022BUT(B)

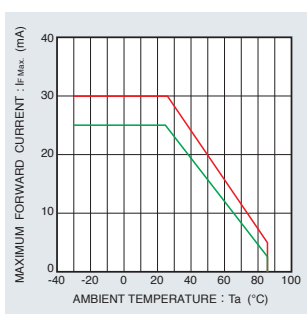

■ SML-020MVT(V)
■ SML-020MVT(M)

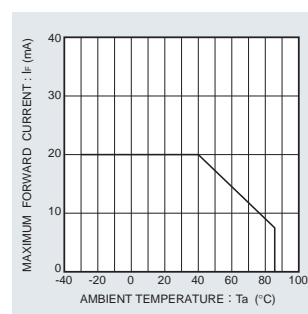

■ SML-022ML8T

1010(0404) /1510(0604) size PICOLED™ -RGB

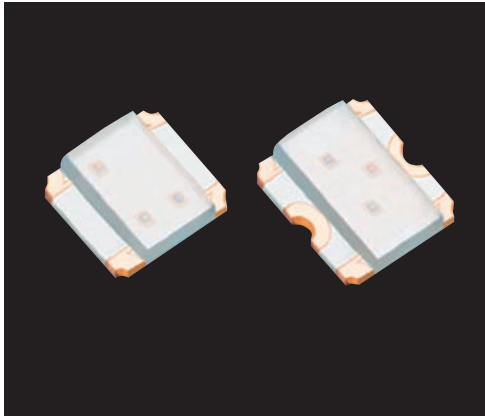

SMLP3 Series

SMLP34RGB1W

Actual Size
 ◆ 1010(0404)
 1.0×1.0mm(t=0.2mm)

SMLP36RGB1W

Actual Size
 ◆ 1510(0604)
 1.5×1.0mm(t=0.2mm)

Features

- The smallest 3 color type LED in the world* PICOLED™ -RGB
- 4pin, 6pin types available
- Low height contributes to the improvement of color mixture

* Investigated Aug. 2009



Specifications

Part No.	Chip Structure	Emitting Color	Absolute Maximum Ratings (Ta=25°C)					Electrical and Optical Characteristics (Ta=25°C)											
			Power Dissipation Pd(mW)	Forward Current IF(mA)	Peak Forward Current I _{FP} (mA)	Reverse Voltage VR(V)	Operating Temperature Topr(°C)	Storage Temperature Tstg(°C)	Forward Voltage VF		Reverse Current IR		Dominant Wavelength λ D			Luminous Intensity Iv			
								Typ.(V)	IF(mA)	Max. (μA)	VR(V)	Min. ⁹² (nm)	Typ. ⁹² (nm)	Max. ⁹² (nm)	IF(mA)	Min. (mcd)	Typ. (mcd)	IF(mA)	
SMLP34RGB1W (3 colors, 4 terminals)	InGaN on SiC	Blue	-	20	100*1	5	-30 to +85	-40 to +100	3.0				465	470	475		9	18	
		Green	-	20	100*1	5	-30 to +85	-40 to +100	3.1	5	100	5	520	527	535	5	22	45	5
	AlGaInP on GaAs	Red							2.1				620	624	629		14	28	
SMLP36RGB1W (3 colors, 6 terminals)	InGaN on SiC	Blue	-	20	100*1	5	-30 to +85	-40 to +100	3.0				465	470	475		9	18	
		Green	-	20	100*1	5	-30 to +85	-40 to +100	3.1	5	100	5	520	527	535	5	22	45	5
	AlGaInP on GaAs	Red							2.1				620	624	629		14	28	

*1:Duty1/20, 1ms *2:Reference

Dimensions

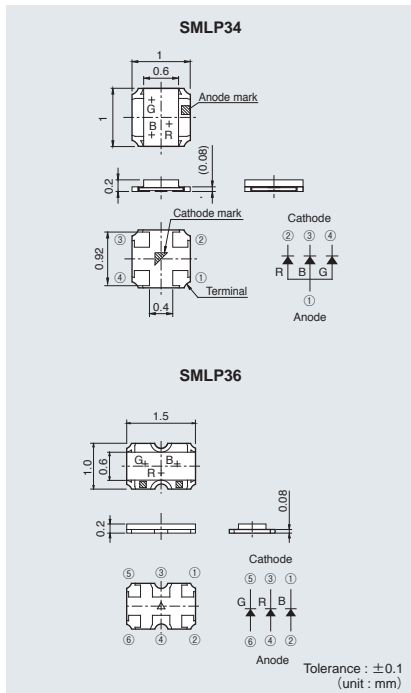

Recommended Solder Pattern

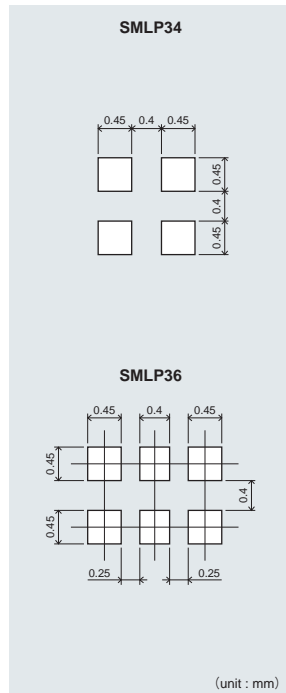

Viewing Angle

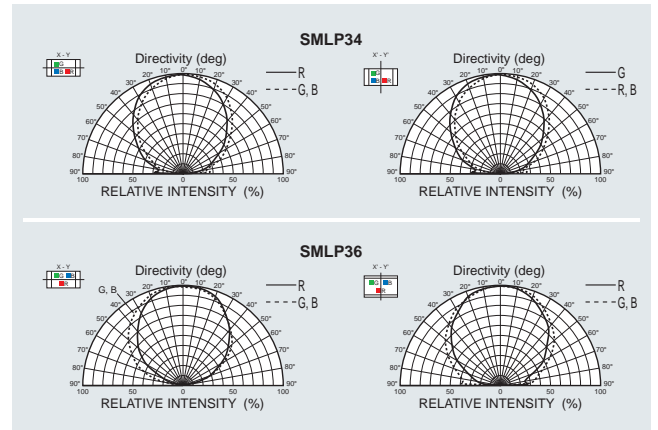

* PICOLED™ is ROHM's pending trademark.

Electrical Characteristics Curves

Forward Current-Forward Voltage

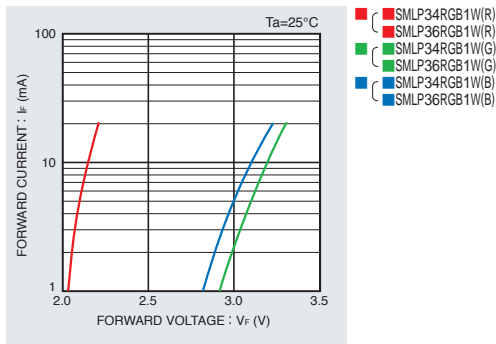

Luminous Intensity-Atmosphere Temperature

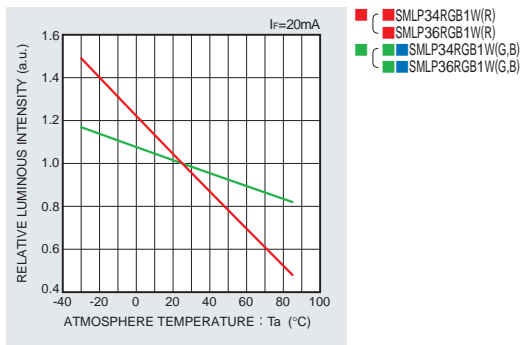

Luminous Intensity-Forward Current

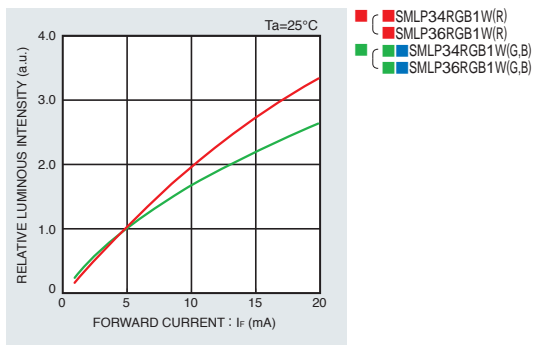

Derating

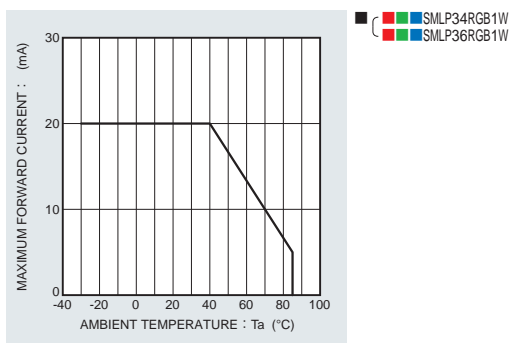

3530(1412) size

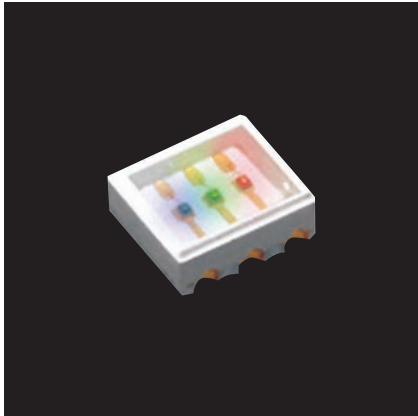

SML032RGB

Actual Size
 3530(1412) size
 3.5×3.0mm (t=1.3mm)

- Features**
- 3-color type LED (standard)



Specifications

Part No.	Chip Structure	Emitting Color	Absolute Maximum Ratings (Ta=25°C)					Electrical and Optical Characteristics (Ta=25°C)										
			Power Dissipation Pd(mW)	Forward Current IF(mA)	Peak Forward Current I _{FP} (mA)	Reverse Voltage VR(V)	Operating Temperature Topr(°C)	Storage Temperature Tstg(°C)	Forward Voltage VF		Reverse Current IR		Dominant Wavelength λ D			Luminous Intensity Iv		
							Typ.(V)	IF(mA)	Max.(μA)	VR(V)	Min.*2 (nm)	Typ.*2 (nm)	Max.*2 (nm)	IF(mA)	Min. (mcd)	Typ. (mcd)	IF(mA)	
SML032RGB1T	InGaN on SiC	Blue	78	20	100*1	5	-40 to +85	-40 to +100	3.2	20	100	5	465	470	480	20	50	125
		Green											520	530	540		200	500
	AlGaInP on GaP	Red	84	30					2.2				620	630	638		140	350

* 1:Duty1/20, 1ms * 2:Reference

Dimensions

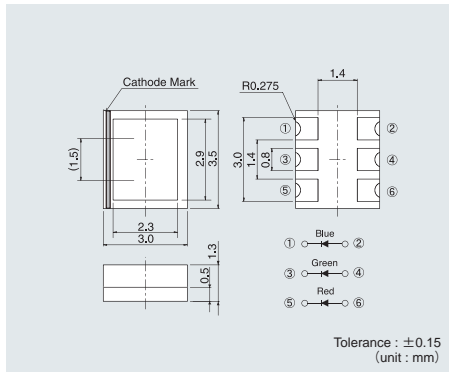

Recommended Solder Pattern Viewing Angle

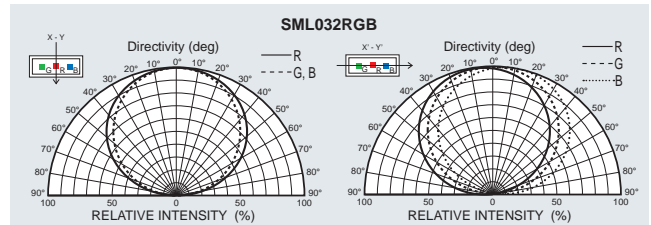
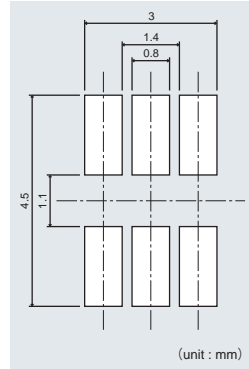

Electrical Characteristics Curves

Forward Current-Forward Voltage

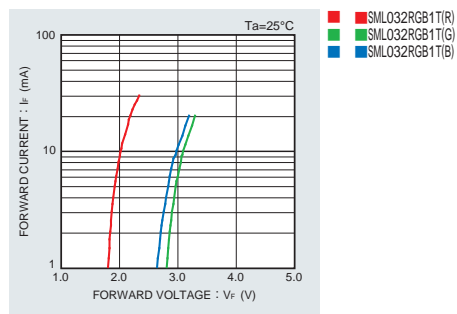

Luminous Intensity-Atmosphere Temperature

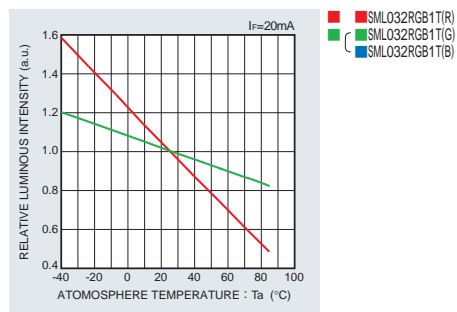

Luminous Intensity-Forward Current

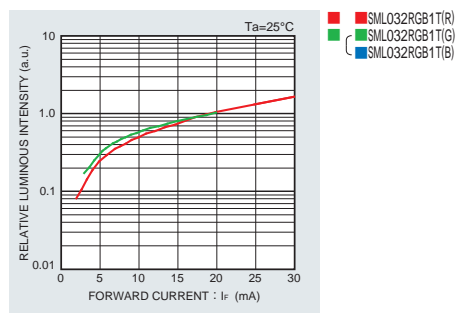

Derating

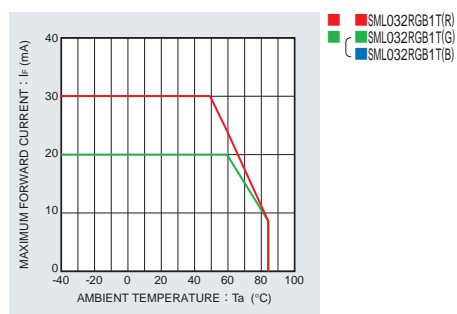

φ 3 Circular type

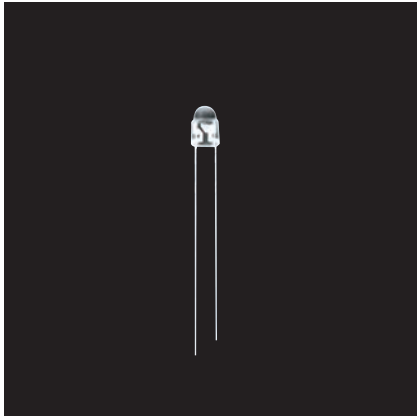

SLR343 / SLI-343 / SLI-343(W) Series

Features

- Viewing angle 2θ 1/2 : 40°
- High brightness (SLR343/SLI-343 series)
- Low power consumption (SLI-343(W) series)
- Competent to direct mount



Specifications

Viewing angle 2θ 1/2 / 40°: High luminous intensity

Part No.	Chip Structure	Emitting Color	Absolute Maximum Ratings (Ta=25°C)					Electrical and Optical Characteristics (Ta=25°C)										
			Power Dissipation PD(mW)	Forward Current IF(mA)	Peak Forward Current IFP(mA)	Reverse Voltage VR(V)	Operating Temperature Topr(°C)	Storage Temperature Tstg(°C)	Forward Voltage VF Typ.(V)	Reverse Current IR Max.(μA)	Reverse Current IR VR(V)	Dominant Wavelength λ D Typ.(nm)	Luminous Intensity Iv Min.(mcd)	Luminous Intensity Iv Typ.(mcd)	Luminous Intensity Iv IFR(mA)			
■ SLR343BD2T	InGaN on SiC	Blue	126	30	100*	5	-20 to +80	3.2		5	470	470	1000					
□ SLR343WBD2PT		White													(x,y) (0.31,0.31)	1500	3300	
■ SLI-343URC	AlGaInP on GaAs	Red	125	50	200*	9	-25 to +85	1.9	20	100	620	90	500	20				
■ SLI-343DC		Orange													605	90	500	
■ SLI-343YC		Yellow													587	350	200	
■ SLI-343MC		Yellowish Green													572	56	200	
■ SLI-343UR		Red													620	350	200	
■ SLI-343DU		Orange													605	90	500	
■ SLI-343YY		Yellow													587	300	200	
■ SLI-343MG		Yellowish Green													572	56	180	200

Viewing angle 2θ 1/2 / 40°: Low current consumption

Part No.	Chip Structure	Emitting Color	Absolute Maximum Ratings (Ta=25°C)					Electrical and Optical Characteristics (Ta=25°C)										
			Power Dissipation PD(mW)	Forward Current IF(mA)	Peak Forward Current IFP(mA)	Reverse Voltage VR(V)	Operating Temperature Topr(°C)	Storage Temperature Tstg(°C)	Forward Voltage VF Typ.(V)	Reverse Current IR Max.(μA)	Reverse Current IR VR(V)	Dominant Wavelength λ D Typ.(nm)	Luminous Intensity Iv Min.(mcd)	Luminous Intensity Iv Typ.(mcd)	Luminous Intensity Iv IFR(mA)			
■ SLI-343URC(W)	AlGaInP on GaAs	Red	125	50	200*	9	-25 to +85	1.9	20	100	9	620	36	200	20			
■ SLI-343DC(W)		Orange														605	56	300
■ SLI-343YC(W)		Yellow														587	200	200
■ SLI-343UR(W)		Red														620	160	200
■ SLI-343DU(W)		Orange														605	56	250
■ SLI-343YY(W)	Yellow	587	36	160	200													

*:Duty1/10, 1kHz

Dimensions

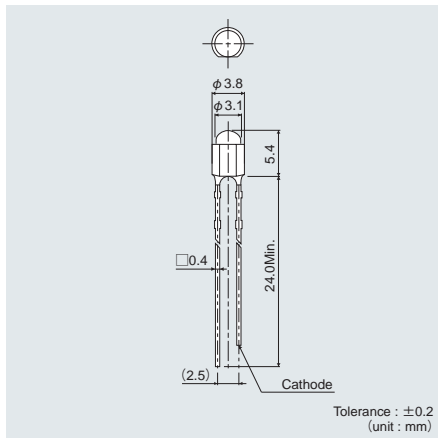

Recommended Solder Pattern Viewing Angle

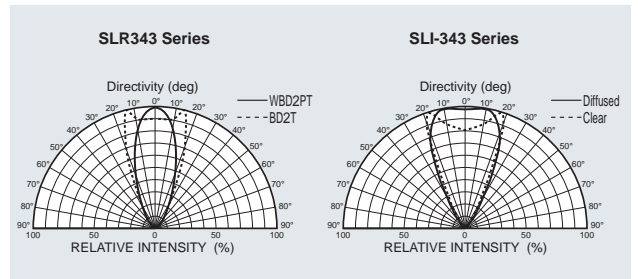
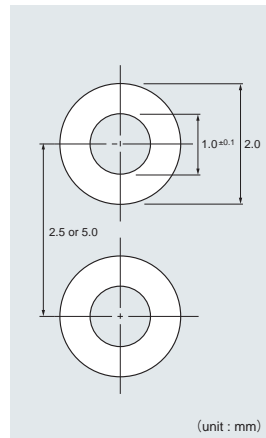

Electrical Characteristics Curves

Forward Current-Forward Voltage

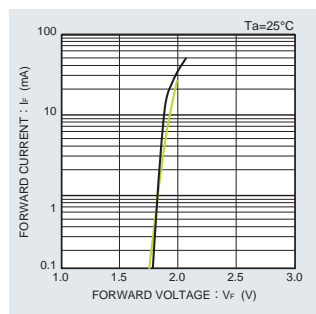

- SLI-343URC
- SLI-343UR
- SLI-343DC
- SLI-343DU
- SLI-343YC
- SLI-343YY
- SLI-343MC
- SLI-343MG

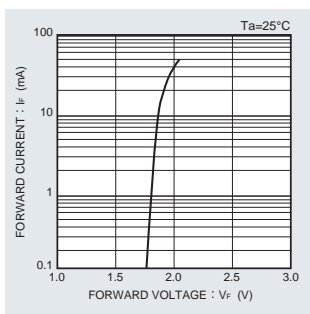

- SLI-343URC(W)
- SLI-343UR(W)
- SLI-343DC(W)
- SLI-343DU(W)
- SLI-343YC(W)
- SLI-343YY(W)

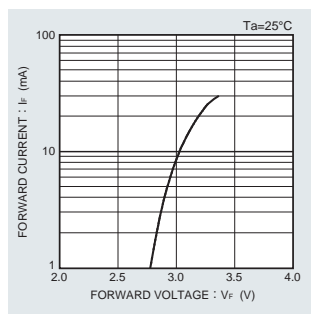

- SLR343BD2T
- SLR343WBD2PT

Luminous Intensity-Atmosphere Temperature

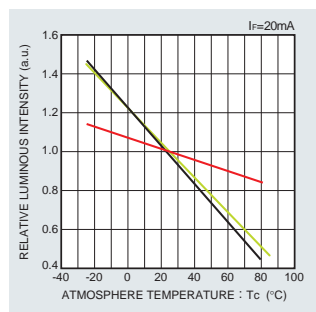

- SLI-343URC
- SLI-343UR
- SLI-343DC
- SLI-343DU
- SLI-343YC
- SLI-343YY
- SLI-343MC
- SLI-343MG

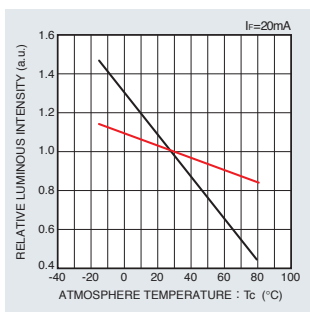

- SLI-343URC(W)
- SLI-343UR(W)
- SLI-343DC(W)
- SLI-343DU(W)
- SLI-343YC(W)
- SLI-343YY(W)

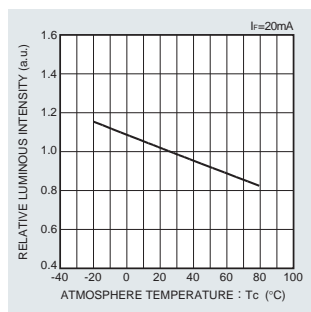

- SLR343BD2T
- SLR343WBD2PT

Luminous Intensity-Forward Current

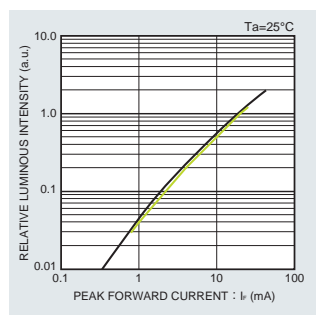

- SLI-343URC
- SLI-343UR
- SLI-343DC
- SLI-343DU
- SLI-343YC
- SLI-343YY
- SLI-343MC
- SLI-343MG

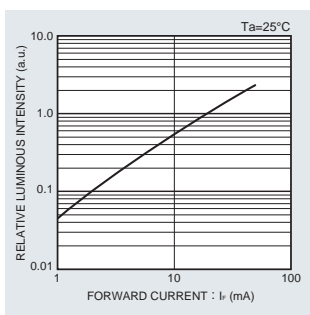

- SLI-343URC(W)
- SLI-343UR(W)
- SLI-343DC(W)
- SLI-343DU(W)
- SLI-343YC(W)
- SLI-343YY(W)

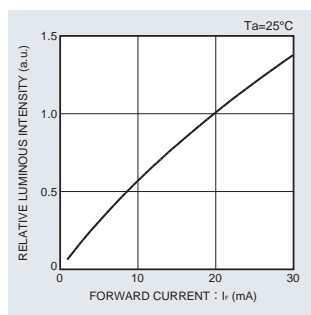

- SLR343BD2T
- SLR343WBD2PT

Derating

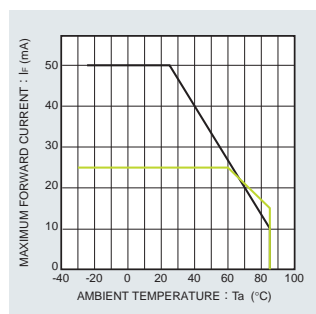

- SLI-343URC
- SLI-343UR
- SLI-343DC
- SLI-343DU
- SLI-343YC
- SLI-343YY
- SLI-343MC
- SLI-343MG

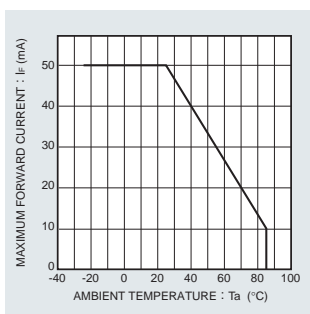

- SLI-343URC(W)
- SLI-343UR(W)
- SLI-343DC(W)
- SLI-343DU(W)
- SLI-343YC(W)
- SLI-343YY(W)

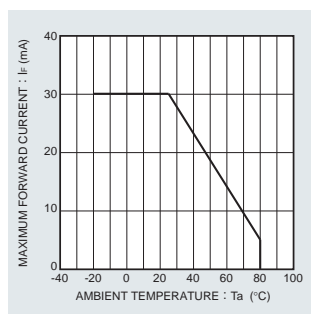

- SLR343BD2T
- SLR343WBD2PT

φ 3 Circular type standard

SLR-343 Series

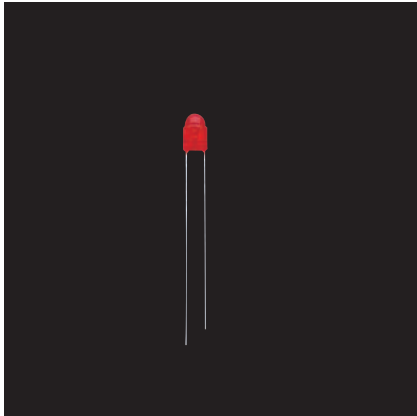

Features

- Viewing angle 2θ 1/2 : 40°
- Competent to direct mount



Specifications

Viewing angle 2θ 1/2 / 40° : Standard

Part No.	Chip Structure	Emitting Color	Absolute Maximum Ratings (Ta=25°C)					Electrical and Optical Characteristics (Ta=25°C)																									
			Power Dissipation Pd (mW)	Forward Current If (mA)	Peak Forward Current Ifp (mA)	Reverse Voltage Vr (V)	Operating Temperature Topr (°C)	Storage Temperature Tstg (°C)	Forward Voltage Vf Typ. (V)	Forward Current If (mA)	Reverse Current Ir Max. (μA)	Reverse Voltage Vr (V)	Dominant Wavelength λ D Typ. (nm)	Luminous Intensity Iv If (mA)	Min. (mcd)	Typ. (mcd)	Iv (mA)																
■ SLR-343VR	GaAsP on GaP	Red	60	20	60*1	3	-25 to +85	-30 to +100	2.0				630		5.6	16																	
■ SLR-343VC																		9.0	25														
■ SLR-343DU		Orange								5.6	16						605		9.0	25													
■ SLR-343DC																																	
■ SLR-343YY	GaP	Yellow	75	25								10	10	3	587	10	3.6	10	10														
■ SLR-343YC																				5.6	16												
■ SLR-343MG		Green																			9.0	25						572		5.6	16		
■ SLR-343MC																																9.0	25
■ SLR-343PG	InGaN on SiC	Bluish Green	120	30					3.3				527		900	2200																	
■ SLR343ECT																				3.2	525	420	1500										
■ SLR343EC4T		Blue																			100*2	5	-20 to +80	-30 to +100						20	200	600	20
■ SLR343BCT																																	
■ SLR343BC7T	White		105	25																													
■ SLR343BC4T																				3.2	200	470											
□ SLR343WBC7T			105	25									(x, y) (0.31, 0.31)	330	680																		

* 1: Duty 1/5, 200Hz * 2: Duty 1/10, 1kHz

Dimensions

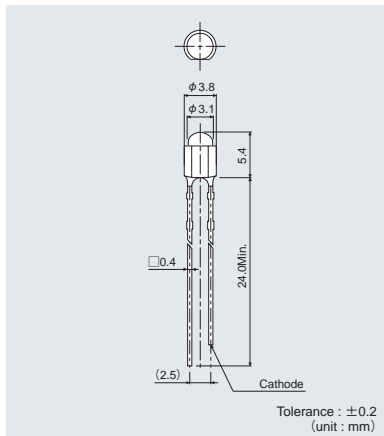

Recommended Solder Pattern

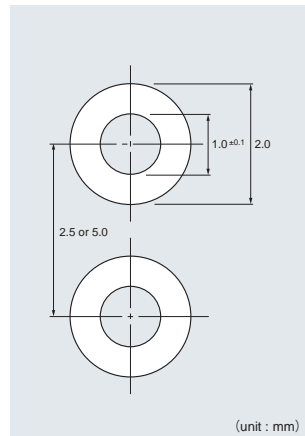

Viewing Angle

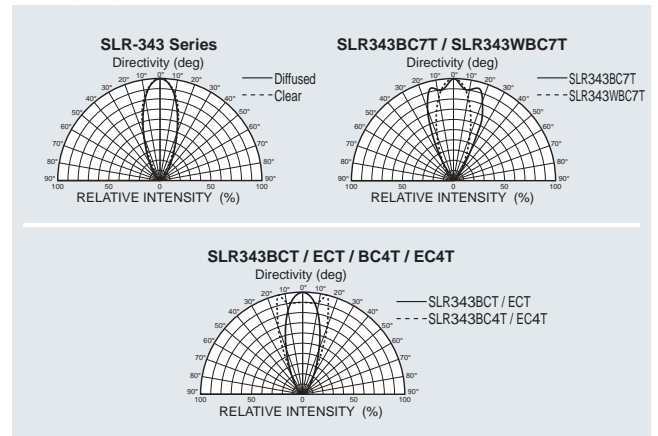

Electrical Characteristics Curves

Forward Current-Forward Voltage

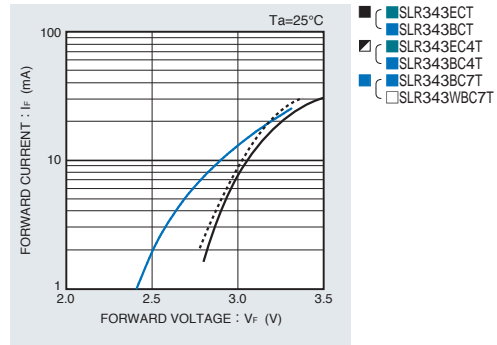
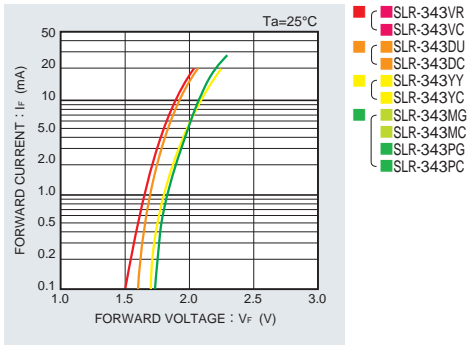

Luminous Intensity-Atmosphere Temperature

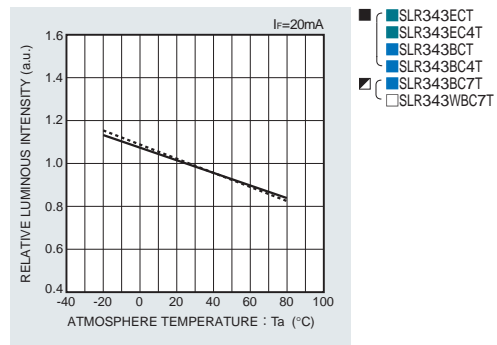
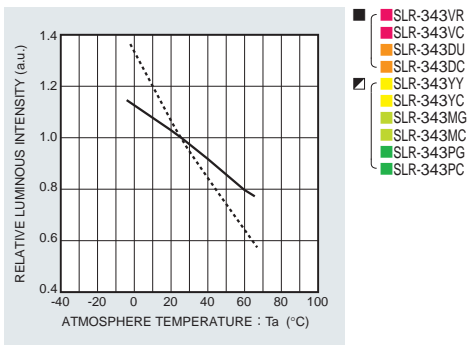

Luminous Intensity-Forward Current

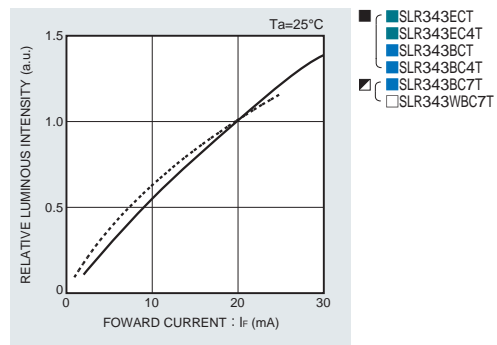
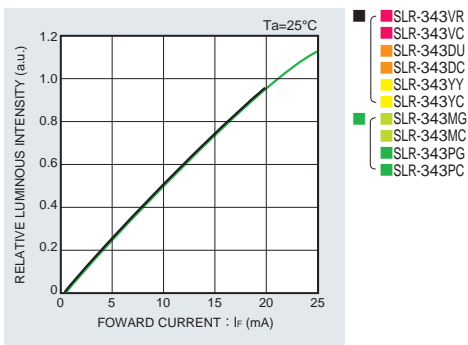

Derating

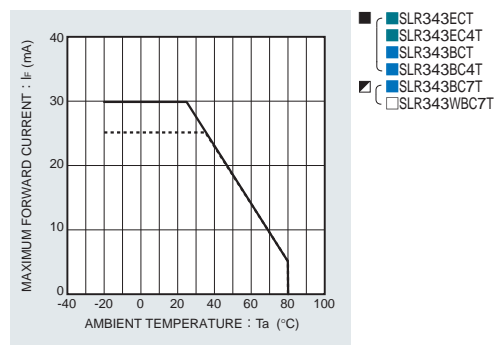
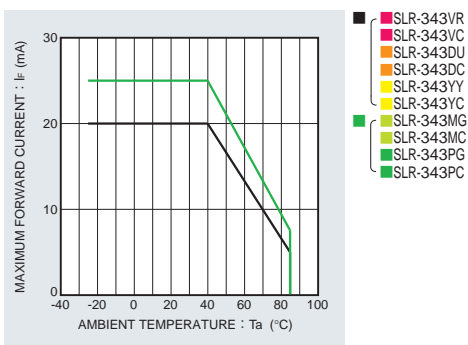

φ 3 Circular type EXCELED™

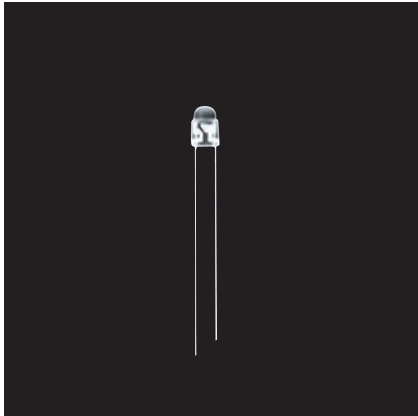

SLI-343□8 Series

Features

- Viewing angle 2θ 1/2 : 40°
- High brightness
- Low current consumption
- Competent to direct mount



Specifications

Viewing angle 2θ 1/2 : 40°: EXCELED™

Part No.	Chip Structure	Emitting Color	Absolute Maximum Ratings (Ta=25°C)					Electrical and Optical Characteristics (Ta=25°C)									
			Power Dissipation Pd (mW)	Forward Current If (mA)	Peak Forward Current IFP (mA)	Reverse Voltage VR (V)	Operating Temperature Topr (°C)	Storage Temperature Tstg (°C)	Forward Voltage VF Typ. (V)	VF (mA)	Reverse Current IR Max. (μA)	VR (V)	Dominant Wavelength λ D Typ. (nm)	Beam Diameter φ (mm)	Min. Luminous Intensity (mcd)	Typ. Luminous Intensity (mcd)	IF (mA)
■ SLI-343V8RC	AlGaInP on GaAs	Red	54	20	100*	9	-30 to +85	-40 to +100	2.2	20	10	9	630	20	150	330	20
■ SLI-343U8RC		620															
■ SLI-343D8C		Orange											605				
■ SLI-343Y8C		Yellow											590				
■ SLI-343M8C		Yellowish Green											572				
■ SLI-343P8C		Green											560				
■ SLI-343V8R		Red											630				
■ SLI-343U8R		620															
■ SLI-343D8U		Orange											605				
■ SLI-343Y8Y		Yellow											590				
■ SLI-343M8G		Yellowish Green											572				
■ SLI-343P8G		Green											560				

*: Duty 1/10, 1kHz

Dimensions

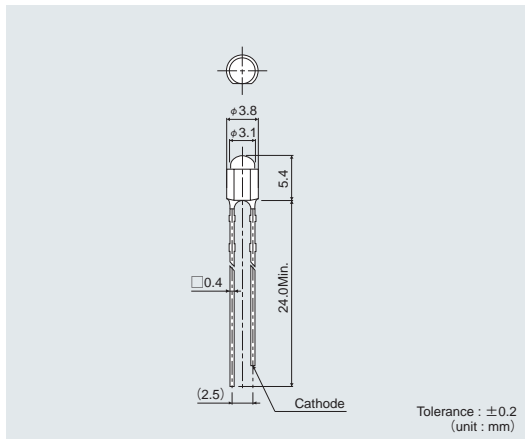

Recommended Solder Pattern

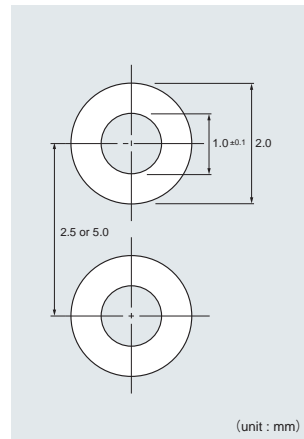

Viewing Angle

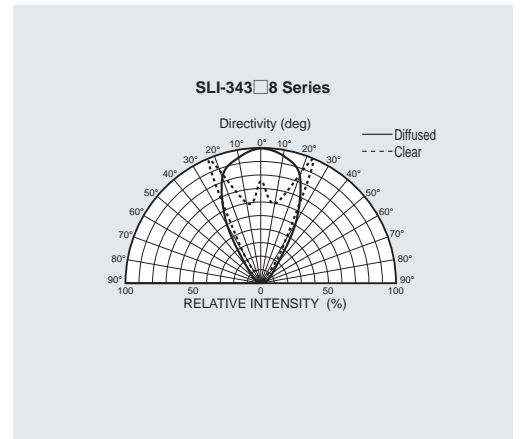

*EXCELED™ is ROHM's pending trademark.

Electrical Characteristics Curves

Forward Current-Forward Voltage

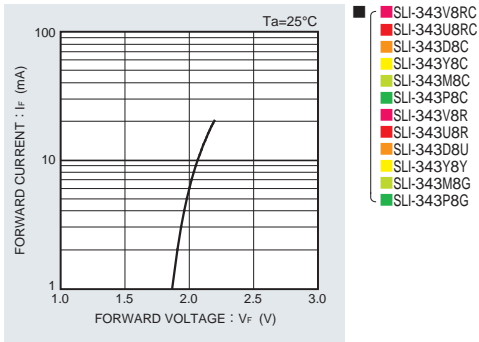

Luminous Intensity-Atmosphere Temperature

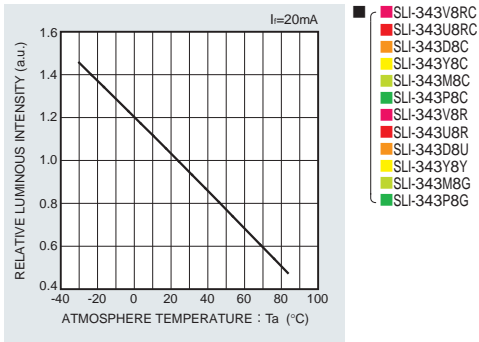

Luminous Intensity-Forward Current

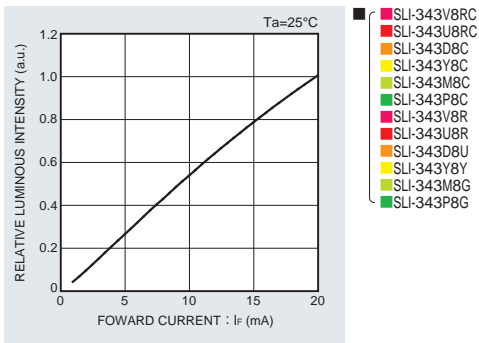

Derating

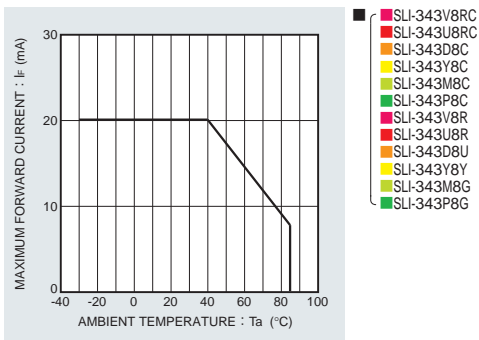

φ 3 Circular type high brightness / standard

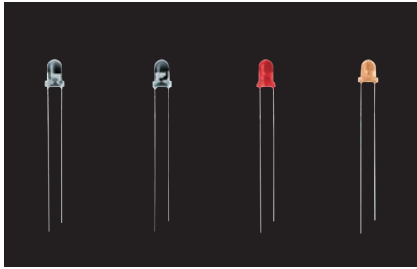

SLA-370 / SLA-360 / SLR-342 / SLR-332 Series

Features

- Viewing angle 2θ 1/2 : 25° (SLA-370MT)
- Viewing angle 2θ 1/2 : 40° (SLA-360MT, SLR-342 series)
- Viewing angle 2θ 1/2 : 85° (SLR-332 series)



Specifications

Viewing angle 2θ 1/2 / 25°, 40°: Standard

Part No.	Chip Structure	Emitting Color	Absolute Maximum Ratings (Ta=25°C)						Electrical and Optical Characteristics (Ta=25°C)								
			Power Dissipation Pd(mW)	Forward Current If(mA)	Peak Forward Current Ifp(mA)	Reverse Voltage Vr(V)	Operating Temperature Topr(°C)	Storage Temperature Tstg(°C)	Forward Voltage V _F Typ.(V)	Forward Current If(mA)	Reverse Current I _R Max.(μA)	Reverse Voltage Vr(V)	Dominant Wavelength λ D Typ.(nm)		Luminous Intensity I _v Min.(mcd)		Luminous Intensity I _v Typ.(mcd)
■ SLA-370MT	GaP	Yellowish Green	75	25	60*1	4	-25 to +85	-30 to +100	2.3	20	10	4	570		42	100	20
■ SLA-360MT																	

Viewing angle 2θ 1/2 / 40°: Standard

Part No.	Chip Structure	Emitting Color	Absolute Maximum Ratings (Ta=25°C)						Electrical and Optical Characteristics (Ta=25°C)								
			Power Dissipation Pd(mW)	Forward Current If(mA)	Peak Forward Current Ifp(mA)	Reverse Voltage Vr(V)	Operating Temperature Topr(°C)	Storage Temperature Tstg(°C)	Forward Voltage V _F Typ.(V)	Forward Current If(mA)	Reverse Current I _R Max.(μA)	Reverse Voltage Vr(V)	Dominant Wavelength λ D Typ.(nm)		Luminous Intensity I _v Min.(mcd)		Luminous Intensity I _v Typ.(mcd)
■ SLR-342VC	GaAsP on GaP	Red	60	20	60*1	3	-25 to +85	-30 to +100	2.0				630		9.0	25	
■ SLR-342DC		Orange											605				
■ SLR-342YC		Yellow											587		5.6	16	
■ SLR-342MC	GaP	Yellowish Green	75	25	60*1	3	-25 to +85	-30 to +100	2.1	10	10	3	572		9.0	25	10
■ SLR-342VR	Red	630		5.6									16				
■ SLR-342DU	GaAsP on GaP	Orange	60	20	60*1	3	-25 to +85	-30 to +100	2.0				605		5.6	16	
■ SLR-342YY	Yellow	587		3.6									10				
■ SLR-342MG	GaP	Yellowish Green	75	25	60*1	3	-25 to +85	-30 to +100	2.1				572		5.6	16	

* SLR-342 series are only available as formed lead types. SLR-343 series are recommended for bulk, and straight lead types.

Viewing angle 2θ 1/2 / 85°: Standard

Part No.	Chip Structure	Emitting Color	Absolute Maximum Ratings (Ta=25°C)						Electrical and Optical Characteristics (Ta=25°C)								
			Power Dissipation Pd(mW)	Forward Current If(mA)	Peak Forward Current Ifp(mA)	Reverse Voltage Vr(V)	Operating Temperature Topr(°C)	Storage Temperature Tstg(°C)	Forward Voltage V _F Typ.(V)	Forward Current If(mA)	Reverse Current I _R Max.(μA)	Reverse Voltage Vr(V)	Dominant Wavelength λ D Typ.(nm)		Luminous Intensity I _v Min.(mcd)		Luminous Intensity I _v Typ.(mcd)
■ SLR-332VC	GaAsP on GaP	Red	60	20	60*1	3	-25 to +85	-30 to +100	2.0				630		3.6	10	
■ SLR-332DC		Orange											605		5.6	16	
■ SLR-332YC		Yellow											587		3.6	10	
■ SLR-332MC	GaP	Yellowish Green	75	25	60*1	3	-25 to +85	-30 to +100	2.1	10	10	3	572		5.6	16	10
■ SLR-332VR	Red	630		3.6									10				
■ SLR-332DU	GaAsP on GaP	Orange	60	20	60*1	3	-25 to +85	-30 to +100	2.0				605		2.2	6.3	
■ SLR-332YY	Yellow	587		2.2									6.3				
■ SLR-332MG	GaP	Yellowish Green	75	25	60*1	3	-25 to +85	-30 to +100	2.1				572		5.6	16	

* 1:Duty1/5, 200Hz

Dimensions

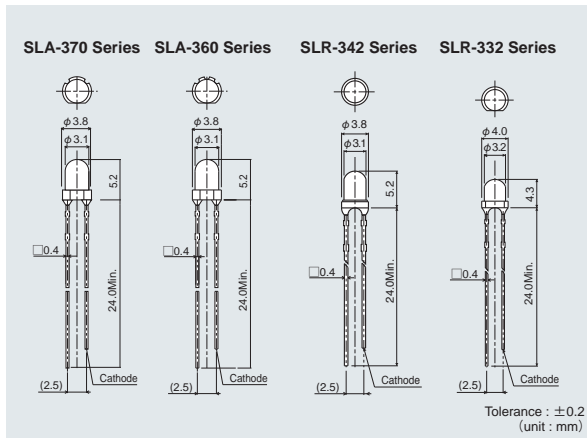

Recommended Solder Pattern Viewing Angle

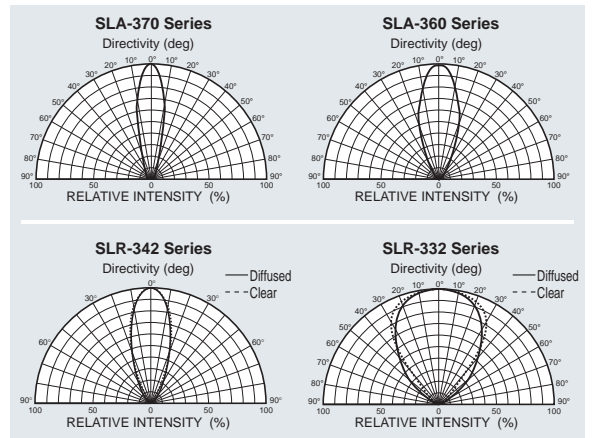
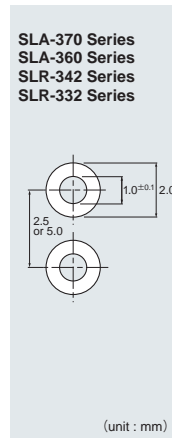

Electrical Characteristics Curves

Forward Current-Forward Voltage

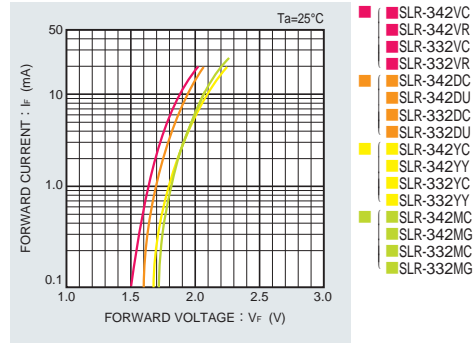
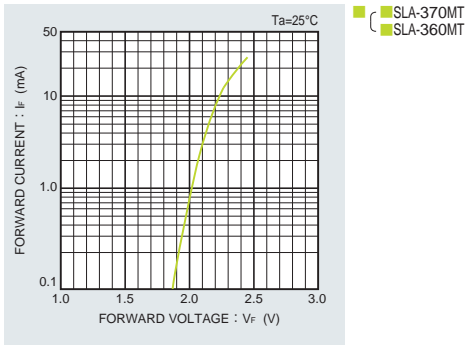

Luminous Intensity-Atmosphere Temperature

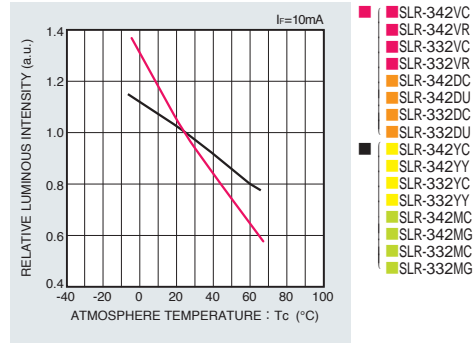
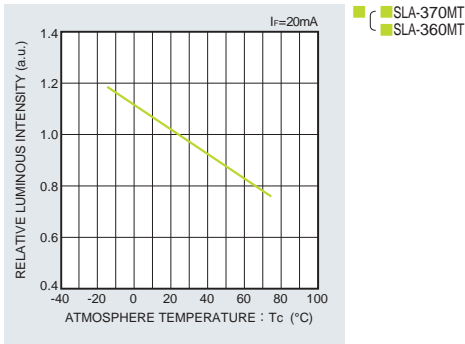

Luminous Intensity-Forward Current

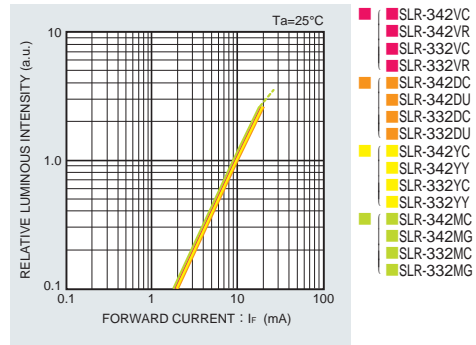
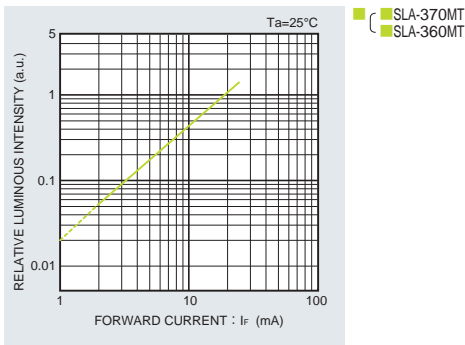

Derating

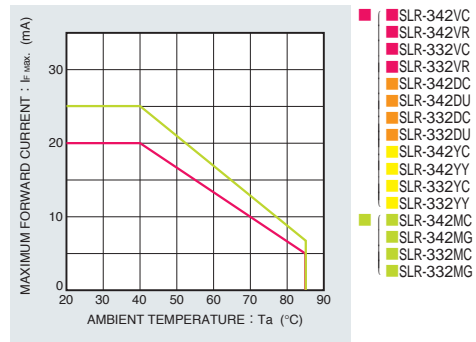
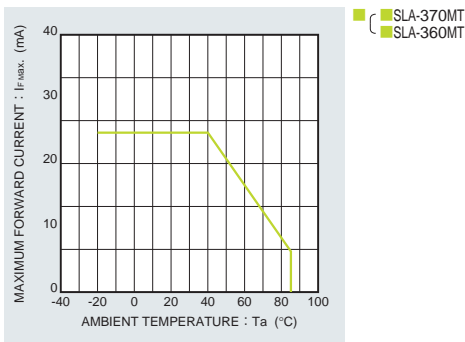

φ 5 Circular type high brightness

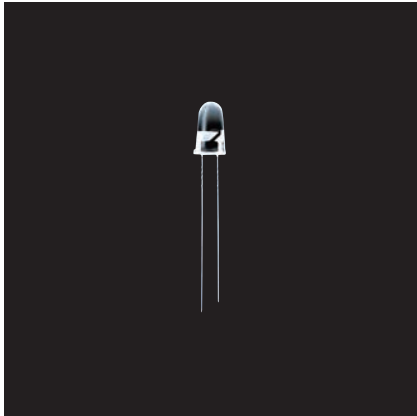

SLI-580 / SLA-580 / SLA580 Series

Features

- Viewing angle 2θ 1/2 : 12°
- High brightness



Specifications

Viewing angle 2θ 1/2 : 12°: High brightness

Part No.	Chip Structure	Emitting Color	Absolute Maximum Ratings (Ta=25°C)						Electrical and Optical Characteristics (Ta=25°C)							
			Power Dissipation Pd(mW)	Forward Current IF(mA)	Peak Forward Current IFP(mA)	Reverse Voltage VR(V)	Operating Temperature Topr(°C)	Storage Temperature Tstg(°C)	Forward Voltage VF Typ.(V)	IF(mA)	Reverse Current IR Max.(μA)	VR(V)	Dominant Wavelength λ D Typ.(nm)	IF(mA)	Luminous Intensity Iv Min.(mcd)	Typ.(mcd)
■ SLI-580UT	AlGaInP on GaAs	Red	125	50	200*2	9	-30 to +85	-40 to +100	1.9	20	100	9	620	2000	5000	20
■ SLI-580DT		Orange											605			
■ SLI-580YT		Yellow											587			
■ SLA-580MT	GaP	Yellowish Green	75	25	60*1	4	-25 to +85	-30 to +100	2.3	20	10	4	572	200	470	20
■ SLA580ECT	InGaN on SiC	Bluish Green	120	30	100*2	5	-20 to +80	-30 to +100	3.3				527	3000	8000	
■ SLA580EC4T									3.2				2000	4500		
■ SLA580BCT									Blue	900	2500					
■ SLA580BC4T	3.2	470	610	1500												

*1:Duty1/5, 200Hz *2:Duty1/10, 1kHz

Dimensions

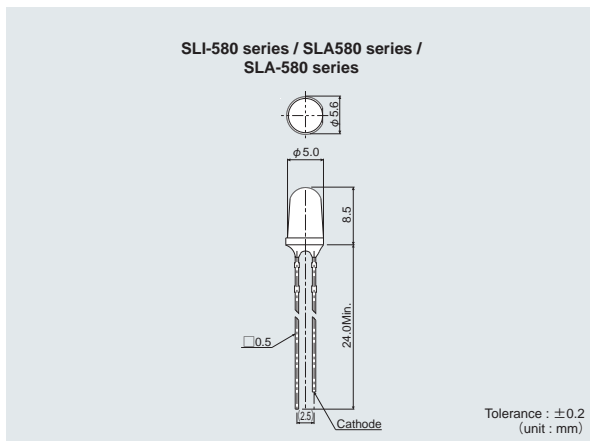

Recommended Solder Pattern

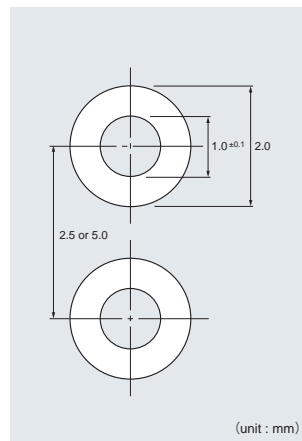

Viewing Angle

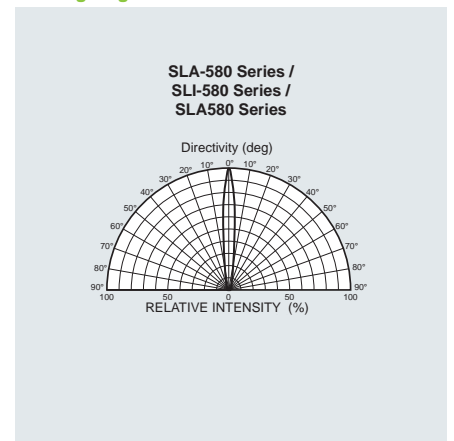

Electrical Characteristics Curves

Forward Current-Forward Voltages

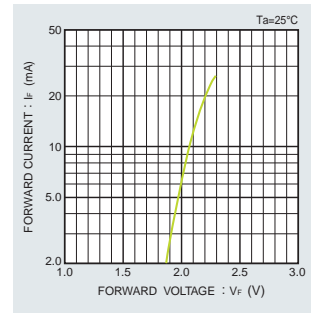
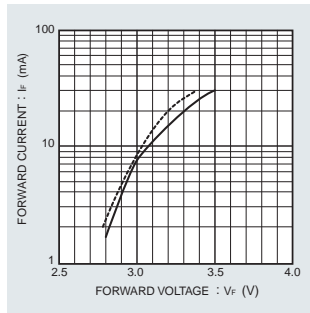
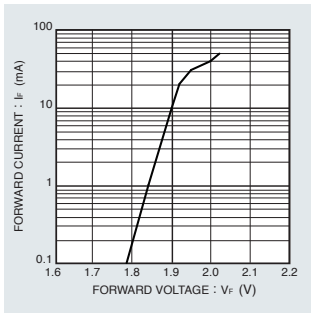

Luminous Intensity-Atmosphere Temperature

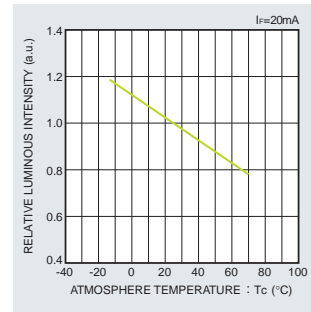
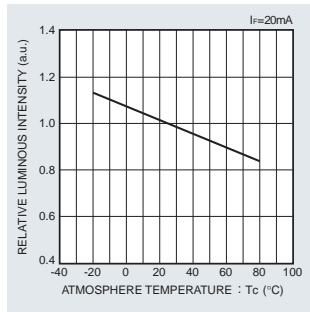
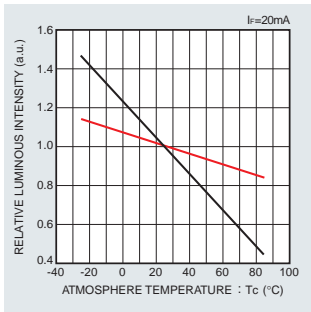

Luminous Intensity-Forward Current

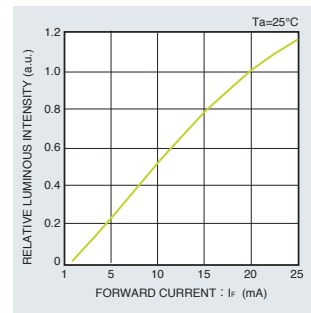
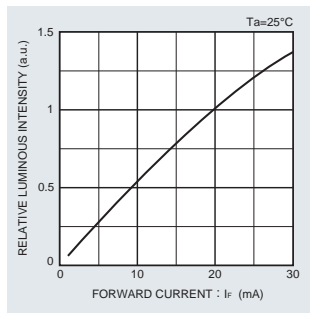
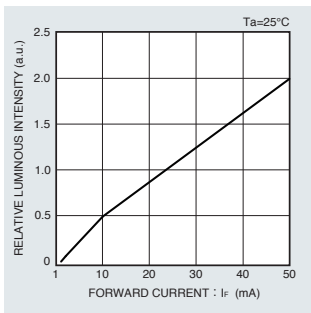

Derating

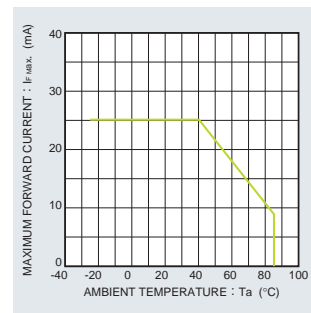
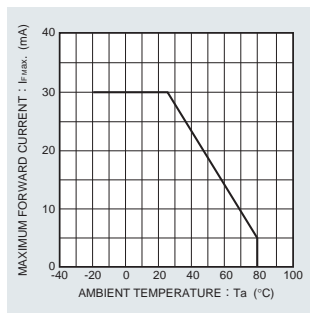
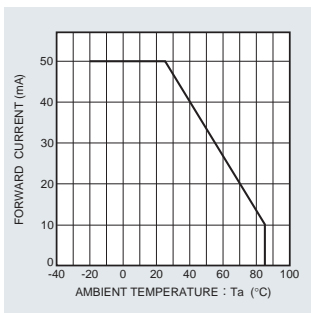

φ 5 Circular type high brightness

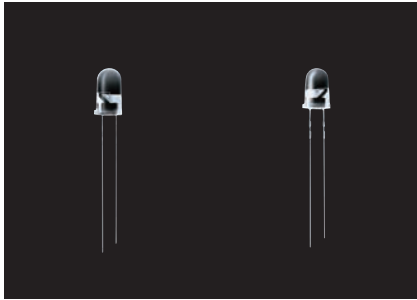

SLI-570 / SLA-570 / SLI-560 / SLA-560 Series

Features

- Viewing angle 2θ 1/2 : 20° (SLI-570 Series)
- Viewing angle 2θ 1/2 : 25° (SLA-570 Series)
- Viewing angle 2θ 1/2 : 40° (SLI-560, SLA560 Series)
- High brightness



Specifications

Viewing angle 2θ 1/2 / 20°: High brightness

Part No.	Chip Structure	Emitting Color	Absolute Maximum Ratings (Ta=25°C)					Electrical and Optical Characteristics (Ta=25°C)									
			Power Dissipation Pd (mW)	Forward Current IF (mA)	Peak Forward Current IFP (mA)	Reverse Voltage VR (V)	Operating Temperature Topr (°C)	Storage Temperature Tstg (°C)	Forward Voltage VF Typ. (V)	IF (mA)	Reverse Current IR Max. (μA)	VR (V)	Dominant Wavelength λD Typ. (nm)	IF (mA)	Luminous Intensity Iv Min. (mcd)	Typ. (mcd)	IF (mA)
■ SLI-570U2T	AlGaInP on GaAs	Red											630		2200	4000	
■ SLI-570DT		Orange	125	50	200*2	9	-30 to +85	-40 to +100	1.9	20	100	9	611	20	900	3000	20
■ SLI-570Y2T		Yellow							2.1				591		2200	5200	

Viewing angle 2θ 1/2 / 25°: High brightness

Part No.	Chip Structure	Emitting Color	Absolute Maximum Ratings (Ta=25°C)					Electrical and Optical Characteristics (Ta=25°C)									
			Power Dissipation Pd (mW)	Forward Current IF (mA)	Peak Forward Current IFP (mA)	Reverse Voltage VR (V)	Operating Temperature Topr (°C)	Storage Temperature Tstg (°C)	Forward Voltage VF Typ. (V)	IF (mA)	Reverse Current IR Max. (μA)	VR (V)	Dominant Wavelength λD Typ. (nm)	IF (mA)	Luminous Intensity Iv Min. (mcd)	Typ. (mcd)	IF (mA)
■ SLA-570MT	GaP	Yellowish Green	75	25	60*1	4	-25 to +85	-30 to +100	2.3	20	10	4	563	20	200	470	20

Viewing angle 2θ 1/2 / 40°: High brightness

Part No.	Chip Structure	Emitting Color	Absolute Maximum Ratings (Ta=25°C)					Electrical and Optical Characteristics (Ta=25°C)									
			Power Dissipation Pd (mW)	Forward Current IF (mA)	Peak Forward Current IFP (mA)	Reverse Voltage VR (V)	Operating Temperature Topr (°C)	Storage Temperature Tstg (°C)	Forward Voltage VF Typ. (V)	IF (mA)	Reverse Current IR Max. (μA)	VR (V)	Dominant Wavelength λD Typ. (nm)	IF (mA)	Luminous Intensity Iv Min. (mcd)	Typ. (mcd)	IF (mA)
■ SLI-560UT	AlGaInP on GaAs	Red											630				
■ SLI-560DT		Orange	125	50	200*2	9	-30 to +85	-40 to +100	1.9	20	100	9	611		300	1000	
■ SLI-560YT		Yellow											591	20			20
■ SLA-560MT	GaP	Yellowish Green	75	25	60*1	4	-25 to +85	-30 to +100	2.3	20	10	4	563		42	100	
■ SLA560BD2T	InGaIn on SiC	Blue	126	30	100*2	5	-20 to +80	-30 to +100	3.2	20	100	5	470		1000	2200	
□ SLA560WBD2PT		White											(x, y) (0.31, 0.31)		1500	3300	

* 1:Duty 1/5, 200Hz * 2:Duty 1/10, 1kHz

Dimensions

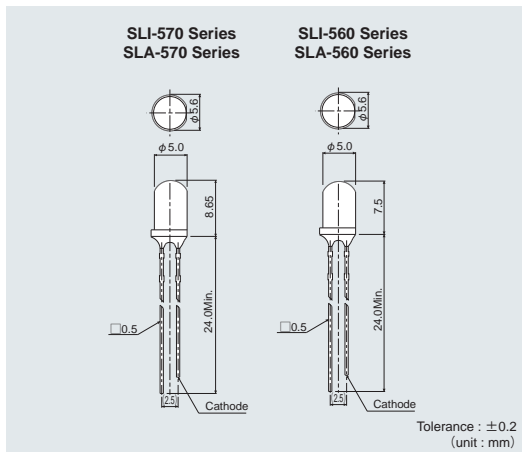

Recommended Solder Pattern Viewing Angle

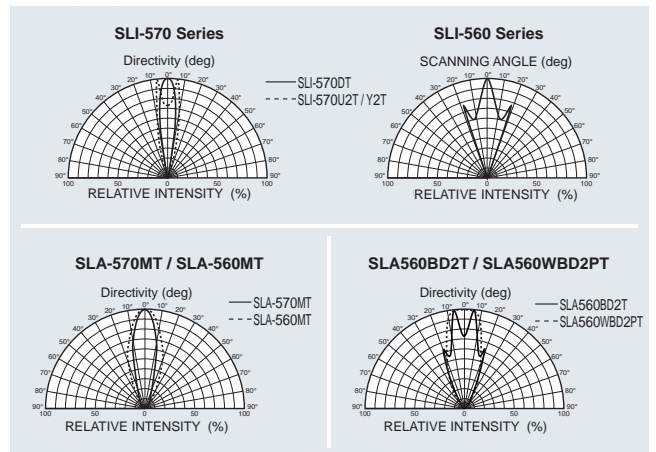
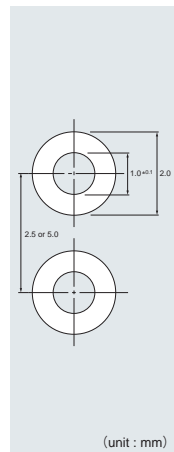

Electrical Characteristics Curves

Forward Current-Forward Voltage

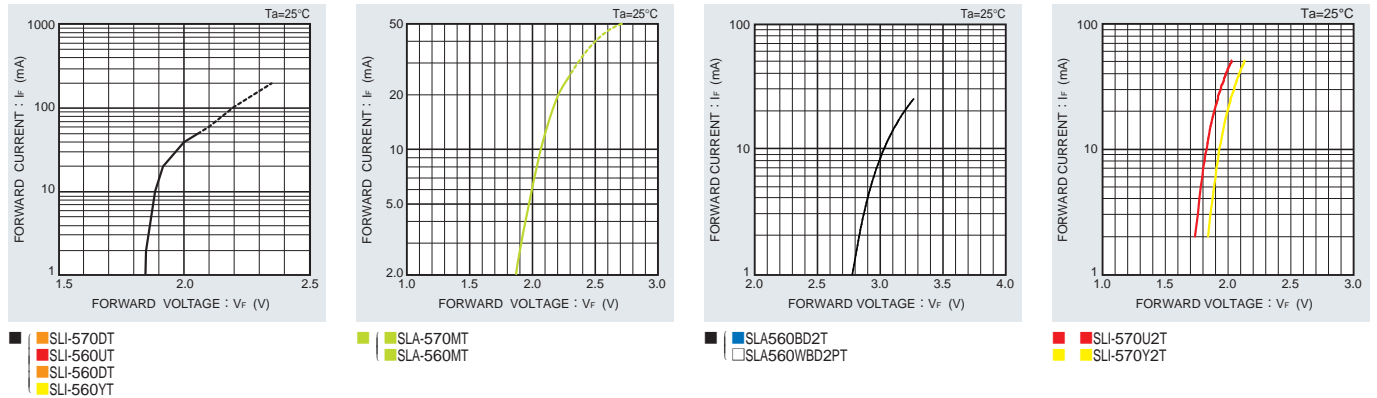

Luminous Intensity-Atmosphere Temperature

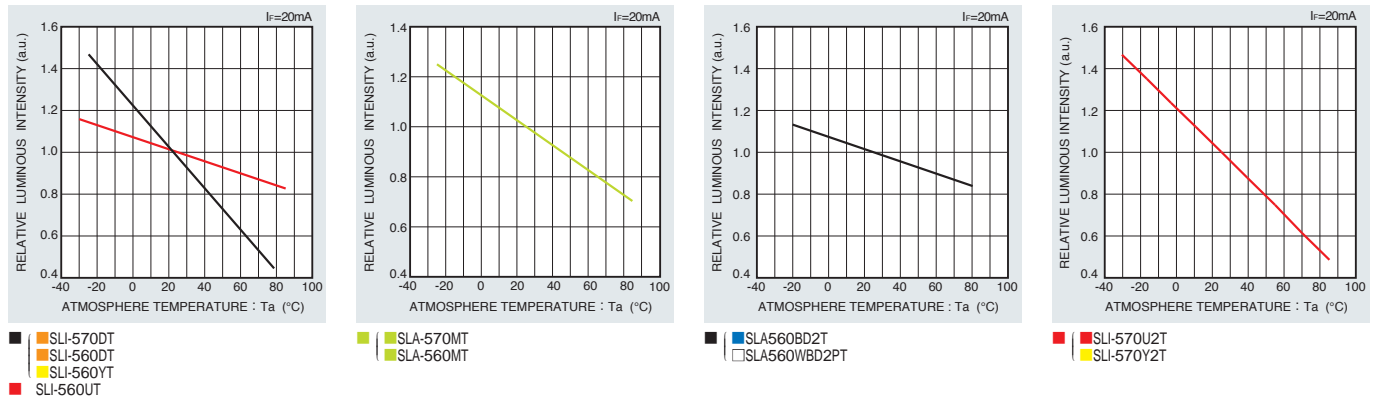

Luminous Intensity-Forward Current

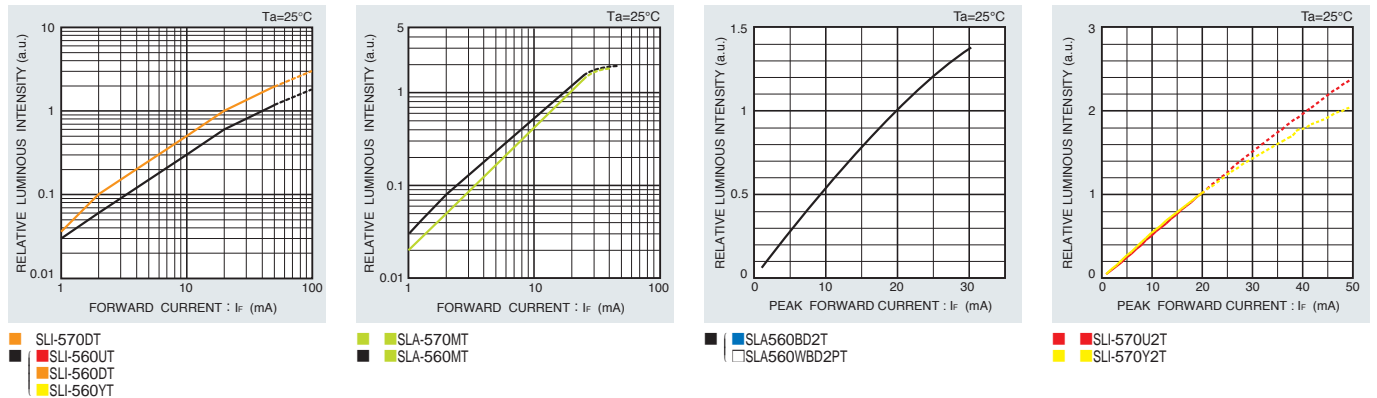

Derating

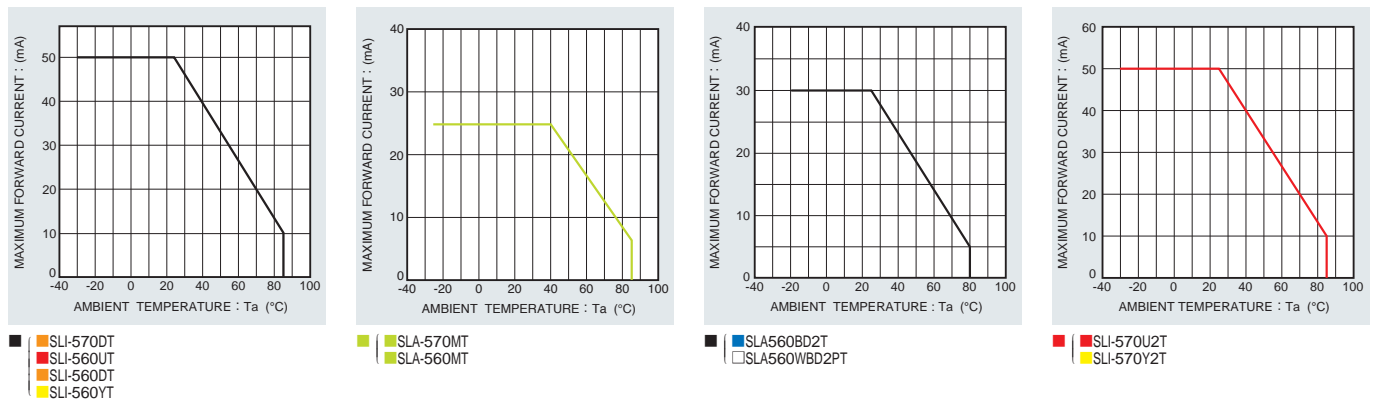

φ5 Circular type standard

SLA560 / SLR-56 Series

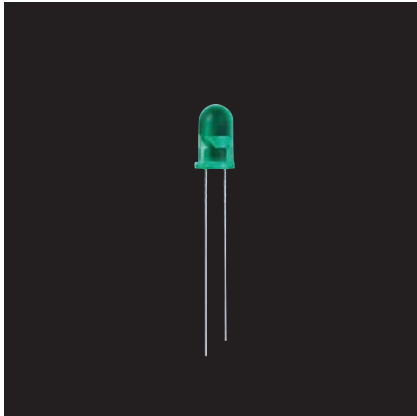

Features

- Viewing angle $2\theta_{1/2} : 40^\circ$

Color Type	V	D	Y
	M	E	B
			W

Specifications

Viewing angle $2\theta_{1/2} / 40^\circ$: Standard

Part No.	Chip Structure	Emitting Color	Absolute Maximum Ratings (Ta=25°C)						Electrical and Optical Characteristics (Ta=25°C)																							
			Power Dissipation Pd(mW)	Forward Current If(mA)	Peak Forward Current IfP(mA)	Reverse Voltage VR(V)	Operating Temperature Topr(°C)	Storage Temperature Tstg(°C)	Forward Voltage VF Typ.(V)	IF(mA)	Reverse Current IR Max.(μA)	VR(V)	Dominant Wavelength λD Typ.(nm)	IF(mA)	Luminous Intensity IV Min.(mcd)	Typ.(mcd)	IV(mA)															
■ SLA560ECT		Bluish Green	120	30					3.3				527		610	2000																
■ SLA560EC4T																																
■ SLA560BC7T	InGaN on SiC	Blue	105	25	100*2	5	-20 to +80	-30 to +100	3.2	20	100	5	470	20	330	680	20															
■ SLA560BCT																																
■ SLA560BC4T																																
□ SLA560WBC7T		White	105	25					3.2				(x,y) (0.31,0.31)		470	1000																
■ SLR-56VC	GaAsP on GaP	Red	60	20					2				630		9	25																
■ SLR-56DC		Orange																														
■ SLR-56YC		Yellow																														
■ SLR-56MC	GaP	Yellowish Green	75	25	60*1	3	-25 to +85	-30 to +100	2.1	10	10	3	572	10	14	40	10															
■ SLR-56VR		Red																														
■ SLR-56DU	GaAsP on GaP	Orange	60	20					2				605		3.6	10																
■ SLR-56YY		Yellow																														
■ SLR-56MG	GaP	Yellowish Green	75	25					2.1				572		5.6	16																

*1:Duty1/5, 200Hz *2:Duty1/10, 1kHz

Dimensions

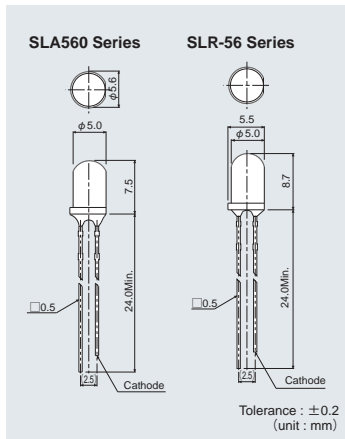

Recommended Solder Pattern Viewing Angle

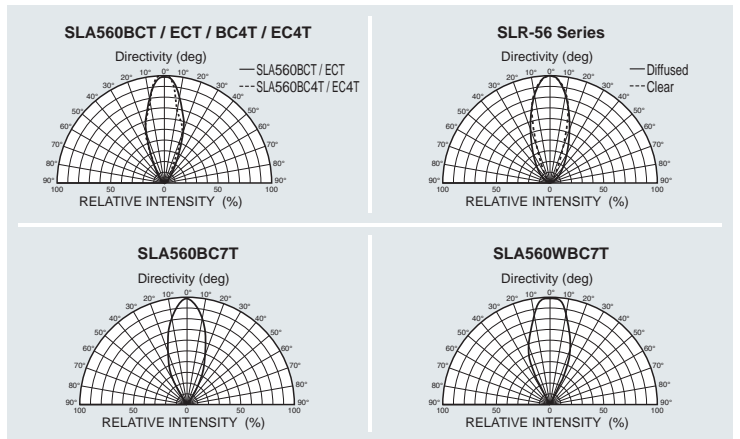
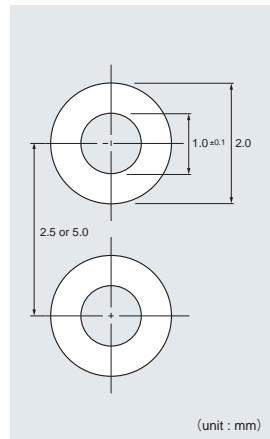

Electrical Characteristics Curves

Forward Current-Forward Voltage

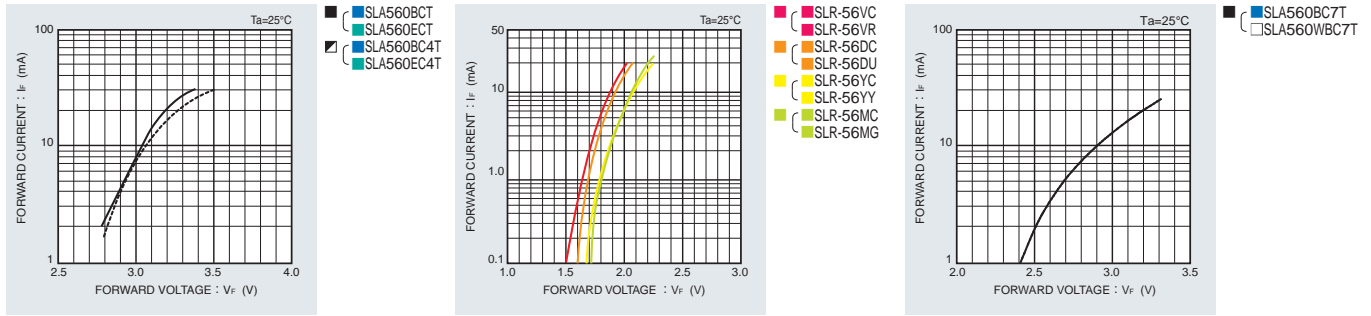

Luminous Intensity-Atmosphere Temperature

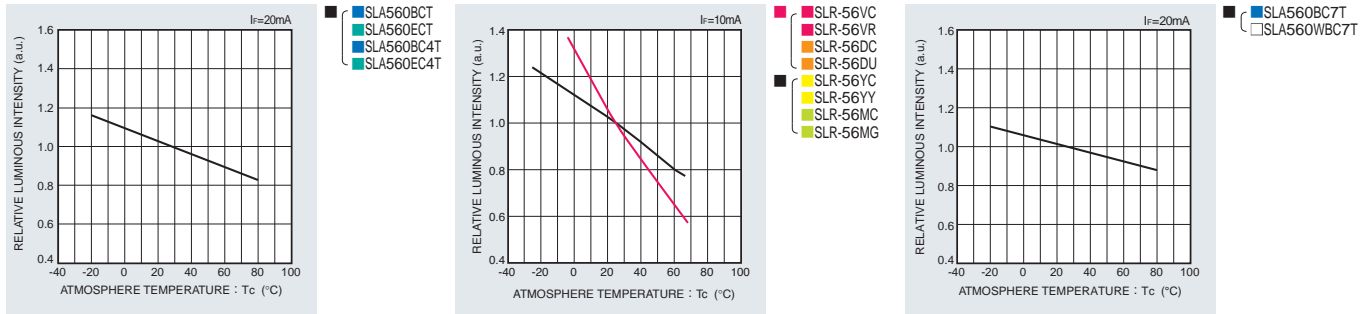

Luminous Intensity-Forward Current

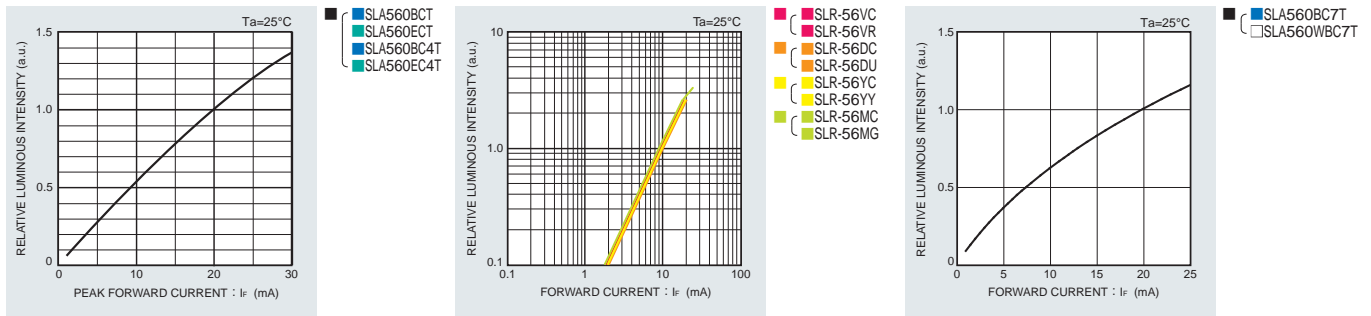

Derating

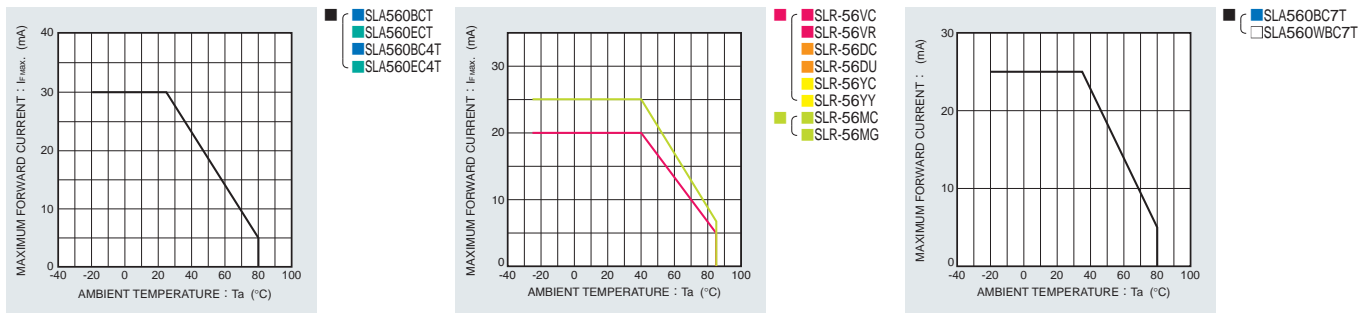

φ 3.2 Circular type

SLI-325 / SLR-325 Series

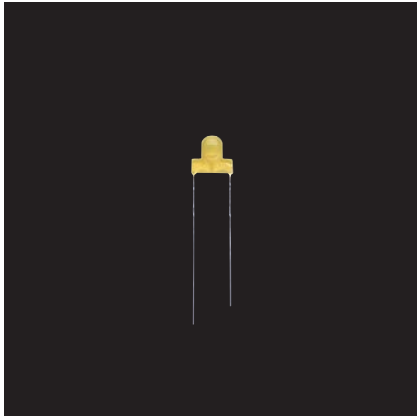

Features

- Viewing angle 2θ 1/2 : 40°
- Lead pitch 5mm
- Low power consumption



Specifications

Viewing angle 2θ 1/2 / 40°: Low power consumption

Part No.	Chip Structure	Emitting Color	Absolute Maximum Ratings (Ta=25°C)					Electrical and Optical Characteristics (Ta=25°C)									
			Power Dissipation Pd(mW)	Forward Current If(mA)	Peak Forward Current Ifp(mA)	Reverse Voltage Vr(V)	Operating Temperature Topr(°C)	Storage Temperature Tstg(°C)	Forward Voltage Vf		Reverse Current Ir		Dominant Wavelength λD		Luminous Intensity Iv		
									Typ.(V)	If(mA)	Max.(μA)	Vr(V)	Typ.(nm)	If(mA)	Min.(mcd)	Typ.(mcd)	If(mA)
■ SLI-325URC(W)	AlGaInP on GaAs	Red	48	20	60*1	4	-25 to +85	-30 to +100	1.85	20	100	4	620	20	36	20	
■ SLI-325DC(W)		Orange							605				160				
■ SLI-325YC(W)		Yellow							587								
■ SLI-325UR(W)		Red							620								
■ SLI-325DU(W)		Orange							605				100				
■ SLI-325YY(W)		Yellow							587								

Viewing angle 2θ 1/2 / 40°: Standard

Part No.	Chip Structure	Emitting Color	Absolute Maximum Ratings (Ta=25°C)					Electrical and Optical Characteristics (Ta=25°C)									
			Power Dissipation Pd(mW)	Forward Current If(mA)	Peak Forward Current Ifp(mA)	Reverse Voltage Vr(V)	Operating Temperature Topr(°C)	Storage Temperature Tstg(°C)	Forward Voltage Vf		Reverse Current Ir		Dominant Wavelength λD		Luminous Intensity Iv		
									Typ.(V)	If(mA)	Max.(μA)	Vr(V)	Typ.(nm)	If(mA)	Min.(mcd)	Typ.(mcd)	If(mA)
■ SLR-325VC	GaAsP on GaP	Red	60	20					2				630		5.6	16	
■ SLR-325DC		Orange							605								
■ SLR-325YC		Yellow							587								
■ SLR-325MC	GaP	Yellowish Green	75	25	60*1	3	-25 to +85	-30 to +100	2.1	10	10	3	572	9	25	10	
■ SLR-325VR	Red	630															
■ SLR-325DU	Orange	605															
■ SLR-325YY	GaAsP on GaP	Yellow							2.1				587	2.2	6.3		
■ SLR-325MG	GaP	Yellowish Green	75	25					2.1				572	5.6	16		

* 1:Duty1/5, 200Hz

* SLI-325/SLR-325 series are only available as straight lead types

Dimensions

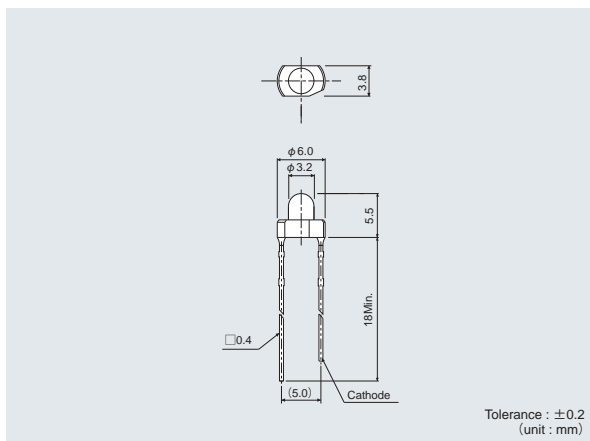

Recommended Solder Pattern

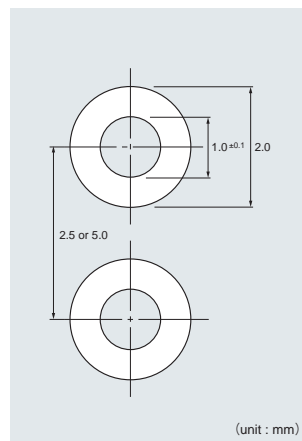

Viewing Angle

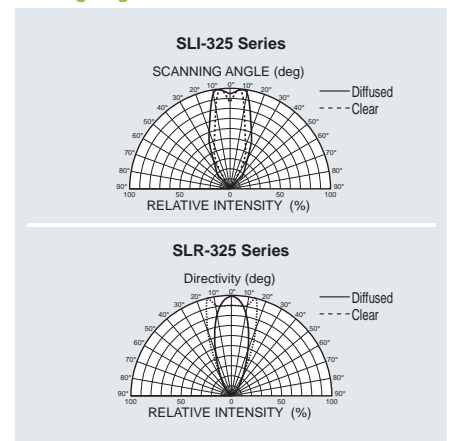

Electrical Characteristics Curves

Forward Current-Forward Voltage

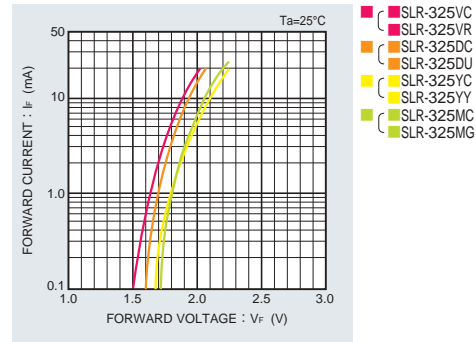
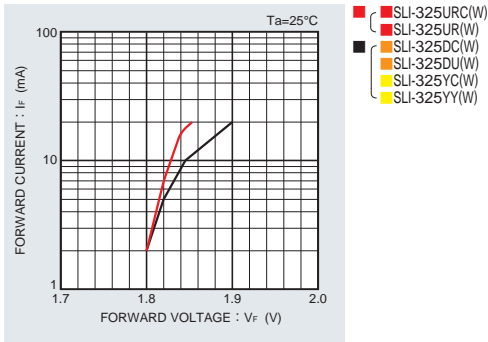

Luminous Intensity-Atmosphere Temperature

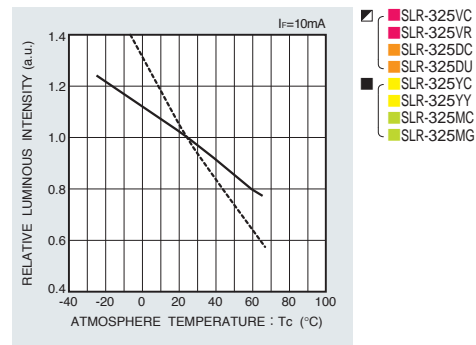
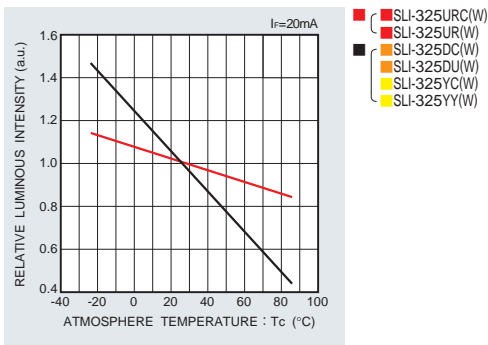

Luminous Intensity-Forward Current

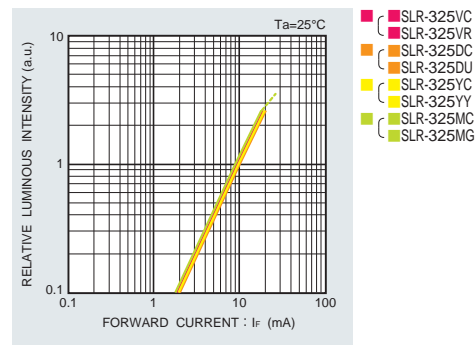
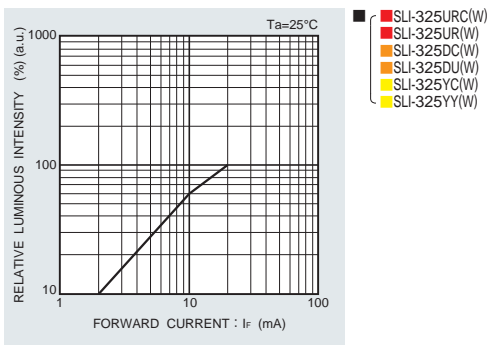

Derating

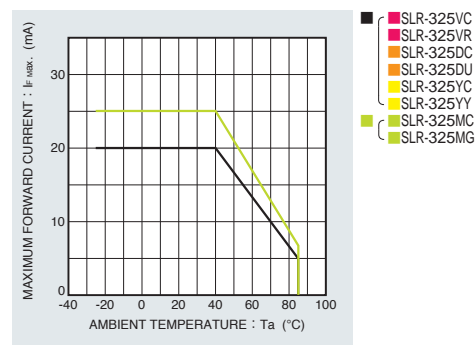
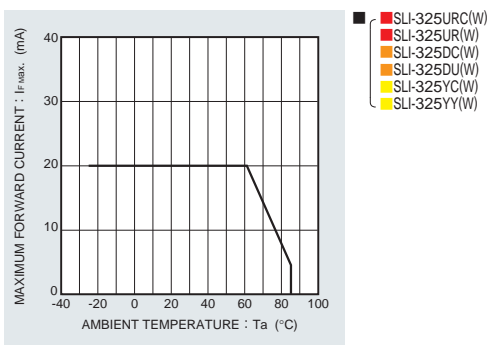

φ 3 Flat disc type standard

SLR-322 Series

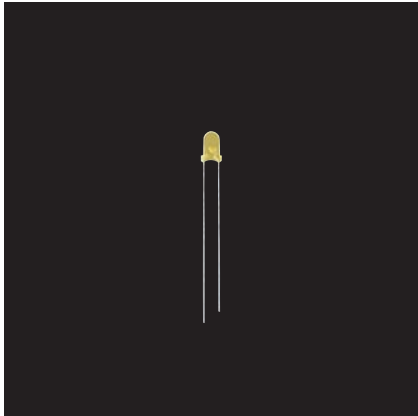

Features

- Viewing angle 2θ 1/2 : 35° (Resin color : Transparent Colored)
- Viewing angle 2θ 1/2 : 50° (Resin color : Diffused Colored)



Specifications

Viewing angle 2θ 1/2 / 35°: Standard

Part No.	Chip Structure	Emitting Color	Absolute Maximum Ratings (Ta=25°C)					Electrical and Optical Characteristics (Ta=25°C)									
			Power Dissipation Pd(mW)	Forward Current IF(mA)	Peak Forward Current IFP(mA)	Reverse Voltage VR(V)	Operating Temperature Topr(°C)	Storage Temperature Tstg(°C)	Forward Voltage VF Typ.(V)	IF(mA)	Reverse Current IR Max.(μA)	VR(V)	Dominant Wavelength λ D Typ.(nm)	IF(mA)	Luminous Intensity Iv Min.(mcd)	Typ.(mcd)	IF(mA)
■ SLR-322VC	GaAsP on GaP	Red	60	20	60*	3	-25 to +85	-30 to +100	2.0	10	10	3	630	10	5.6	16	10
■ SLR-322DC		Orange											605				
■ SLR-322YC		Yellow											587				
■ SLR-322MC	GaP	Yellowish Green	75	25					2.1				572		9	25	

Viewing angle 2θ 1/2 / 50°: Standard

Part No.	Chip Structure	Emitting Color	Absolute Maximum Ratings (Ta=25°C)					Electrical and Optical Characteristics (Ta=25°C)											
			Power Dissipation Pd(mW)	Forward Current IF(mA)	Peak Forward Current IFP(mA)	Reverse Voltage VR(V)	Operating Temperature Topr(°C)	Storage Temperature Tstg(°C)	Forward Voltage VF Typ.(V)	IF(mA)	Reverse Current IR Max.(μA)	VR(V)	Dominant Wavelength λ D Typ.(nm)	IF(mA)	Luminous Intensity Iv Min.(mcd)	Typ.(mcd)	IF(mA)		
■ SLR-322VR	GaAsP on GaP	Red	60	20	60*	3	-25 to +85	-30 to +100	2.0	10	10	3	630	10	3.6	10	10		
■ SLR-322DU		Orange											605					2.2	6.3
■ SLR-322YY		Yellow											587					3.6	10
■ SLR-322MG	GaP	Yellowish Green	75	25					2.1				572		5.6	16			

*: Duty 1/5, 200Hz

Dimensions

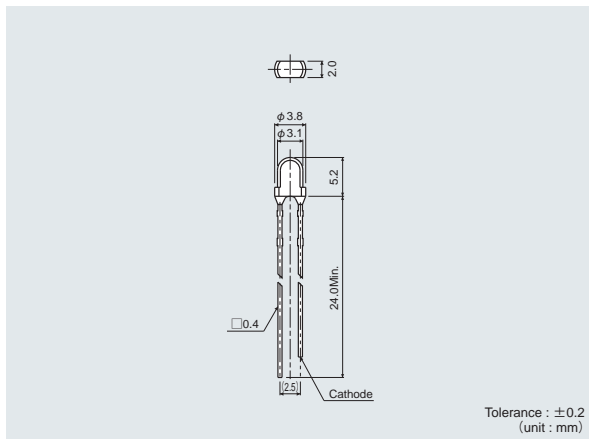

Recommended Solder Pattern

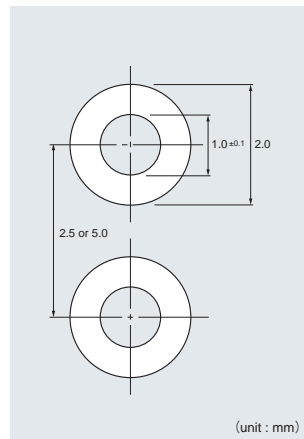

Viewing Angle

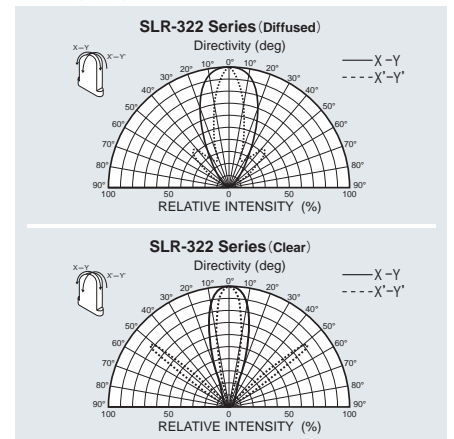

Electrical Characteristics Curves

Forward Current-Forward Voltage

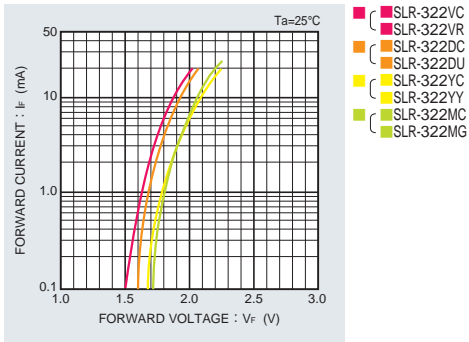

Luminous Intensity-Atmosphere Temperature

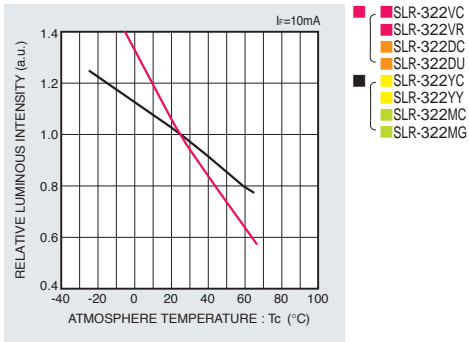

Luminous Intensity-Forward Current

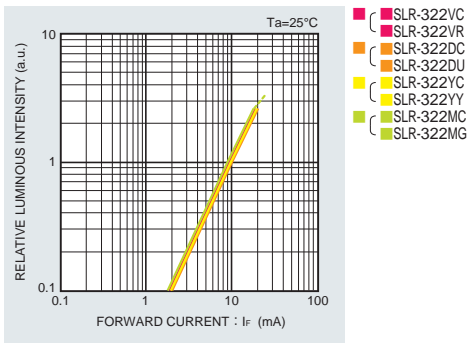

Derating

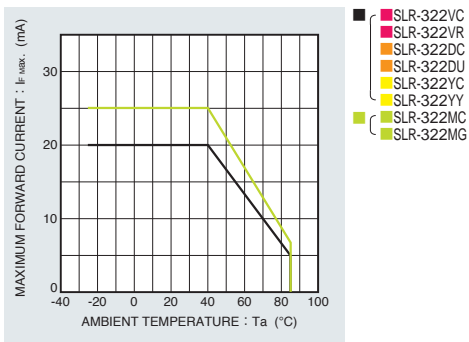

φ2 Cylinder type standard

SLC-22 Series

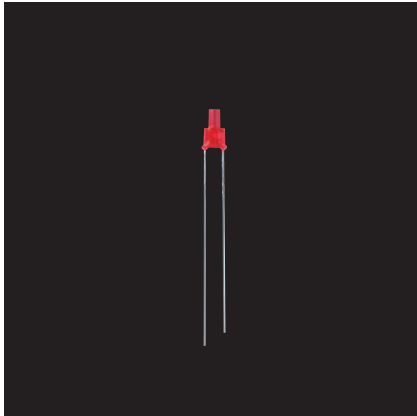

Features

- Viewing angle 2θ 1/2 : 115°



Specifications

Viewing angle 2θ 1/2 : 115° : Standard

Part No.	Chip Structure	Emitting Color	Absolute Maximum Ratings (Ta=25°C)					Electrical and Optical Characteristics (Ta=25°C)									
			Power Dissipation Pd(mW)	Forward Current If(mA)	Peak Forward Current IFP(mA)	Reverse Voltage VR(V)	Operating Temperature Topr(°C)	Storage Temperature Tstg(°C)	Forward Voltage VF Typ.(V)	IF(mA)	Reverse Current IR Max.(μA)	VR(V)	Dominant Wavelength λ D Typ.(nm)	IF(mA)	Luminous Intensity I _v Min.(mcd)	Typ.(mcd)	IF(mA)
■ SLC-22VR	GaAsP on GaP	Red	60	20	60*	3	-25 to +85	-30 to +100	2.0	10	10	3	630	10	0.9	2.5	10
■ SLC-22DU		Orange							605				0.56		1.6		
■ SLC-22YY		Yellow							587				0.9		2.5		
■ SLC-22MG	GaP	Yellowish Green	75	25					2.1				572				

* :Duty1/5, 200Hz

Dimensions

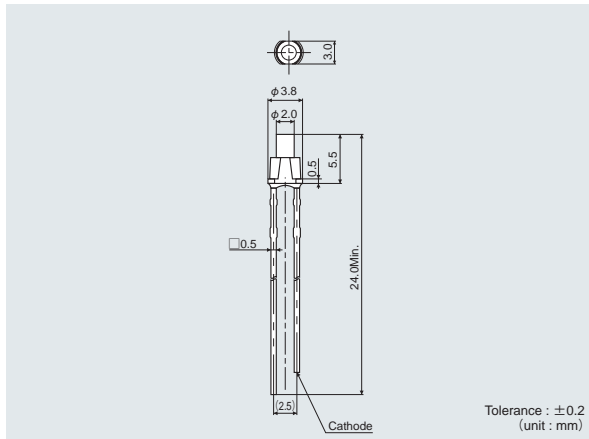

Recommended Solder Pattern

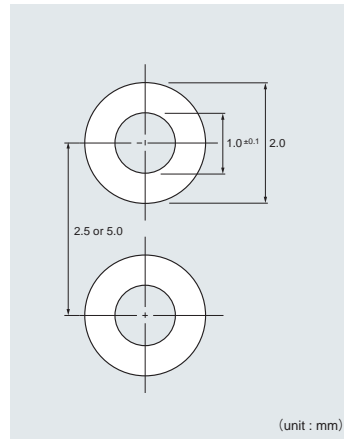

Viewing Angle

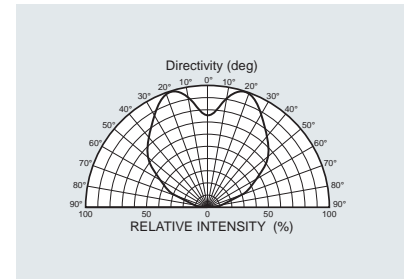

Electrical Characteristics Curves

Forward Current-Forward Voltage

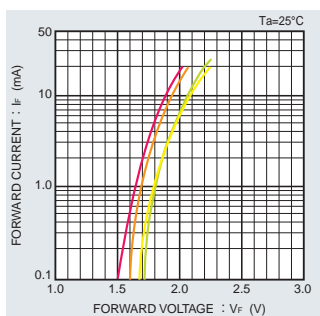

Luminous Intensity-Atmosphere Temperature

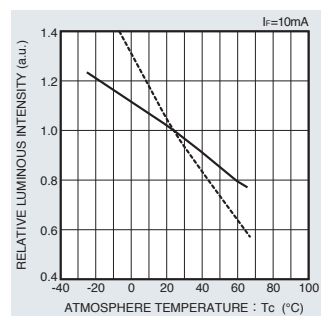

Luminous Intensity-Forward Current

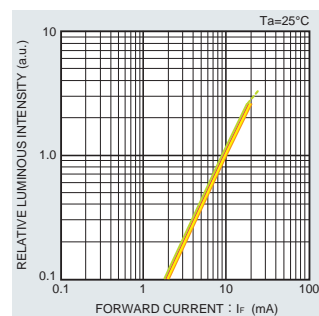

Derating

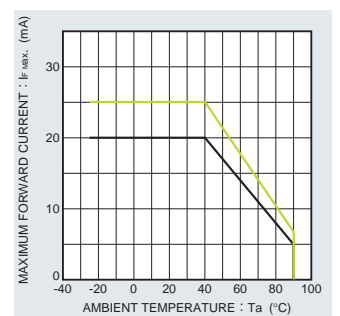

- SLC-22VR
- SLC-22DU
- SLC-22YY
- SLC-22MG

- SLC-22VR
- SLC-22DU
- SLC-22YY
- SLC-22MG

- SLC-22VR
- SLC-22DU
- SLC-22YY
- SLC-22MG

- SLC-22VR
- SLC-22DU
- SLC-22YY
- SLC-22MG

2x5 Square type standard

SLB-25 Series

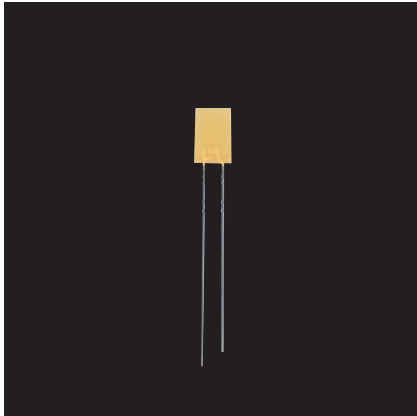

Features

- Viewing angle $2\theta_{1/2}$: 130°



Specifications

Viewing angle $2\theta_{1/2}$: 160°: Standard

Part No.	Chip Structure	Emitting Color	Absolute Maximum Ratings (Ta=25°C)					Electrical and Optical Characteristics (Ta=25°C)									
			Power Dissipation Pd (mW)	Forward Current If (mA)	Peak Forward Current IFP (mA)	Reverse Voltage VR (V)	Operating Temperature Topr (°C)	Storage Temperature Tstg (°C)	Forward Voltage V _F Typ. (V)	Reverse Current I _R Max. (μA)	VR (V)	Dominant Wavelength λ D Typ. (nm)	Luminous Intensity I _v Min. (mcd)	Typ. (mcd)	I _f (mA)		
SLB-25VR	GaAsP on GaP	Red	60	20	60*	3	-25 to +85	-30 to +100	2.0	10	10	3	630	10	0.36	1.0	10
SLB-25DU		Orange							605								
SLB-25YY		Yellow							587								
SLB-25MG	GaP	Yellowish Green	75	25					2.1				572				

*:Duty1/5, 200Hz

Dimensions

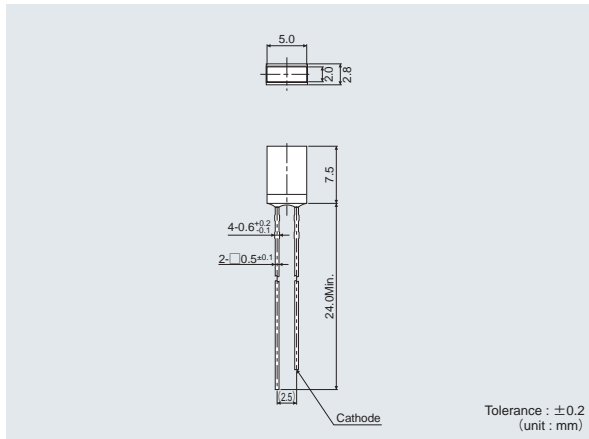

Recommended Solder Pattern

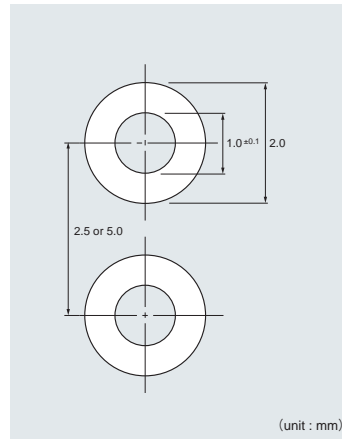

Viewing Angle

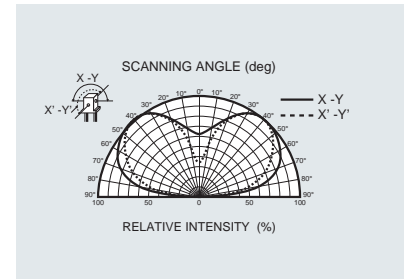

Electrical Characteristics Curves

Forward Current-Forward Voltage

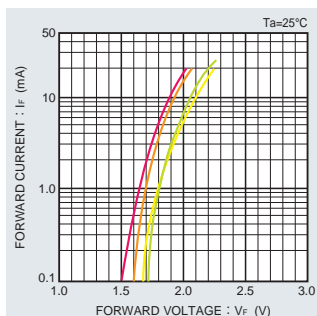

Luminous Intensity-Atmosphere Temperature

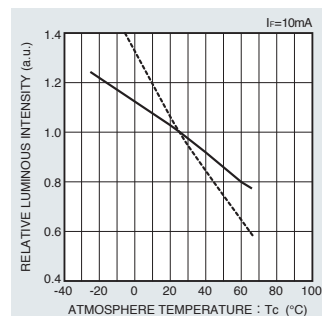

Luminous Intensity-Forward Current

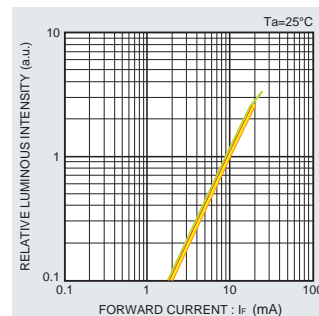

Derating

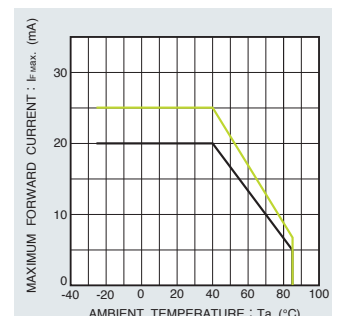

- SLB-25VR
- SLB-25DU
- SLB-25YY
- SLB-25MG

- SLB-25VR
- SLB-25DU
- SLB-25YY
- SLB-25MG

- SLB-25VR
- SLB-25DU
- SLB-25YY
- SLB-25MG

- SLB-25VR
- SLB-25DU
- SLB-25YY
- SLB-25MG

φ 3.1 / φ 5 Dual-color type standard

SPR-39 / SPR-54 Series

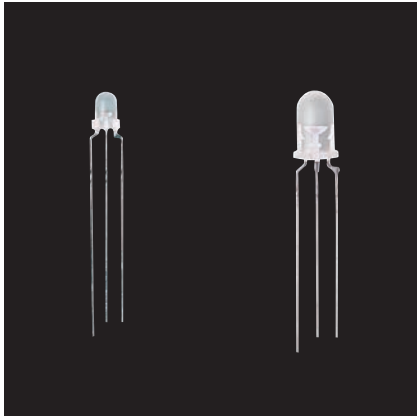

Features

- Viewing angle 2θ 1/2 : 35° (SPR-39MVW)
- Viewing angle 2θ 1/2 : 40° (SPR-54MVW)



Specifications

Viewing angle 2θ 1/2 : 35°: Standard

Part No.	Chip Structure	Emitting Color	Absolute Maximum Ratings (Ta=25°C)						Electrical and Optical Characteristics (Ta=25°C)								
			Power Dissipation Pd(mW)	Forward Current If(mA)	Peak Forward Current Ifp(mA)	Reverse Voltage Vr(V)	Operating Temperature Topr(°C)	Storage Temperature Tstg(°C)	Forward Voltage Vf		Reverse Current Ir	Dominant Wavelength		Luminous Intensity Iv			
									Typ.(V)	If(mA)		Max.(μA)	Vr(V)	λ D Typ.(nm)	If(mA)	Min. (mcd)	Typ. (mcd)
■ ■ SPR-39MVW	GaAsP on GaP	Red	60	20	60*1	3	-25 to +85	-30 to +100	2.0	10	100	3	572	10	2.2	6.3	10
	GaP	Yellowish Green	75	25					2.1								

Viewing angle 2θ 1/2 : 45°: Standard

Part No.	Chip Structure	Emitting Color	Absolute Maximum Ratings (Ta=25°C)						Electrical and Optical Characteristics (Ta=25°C)								
			Power Dissipation Pd(mW)	Forward Current If(mA)	Peak Forward Current Ifp(mA)	Reverse Voltage Vr(V)	Operating Temperature Topr(°C)	Storage Temperature Tstg(°C)	Forward Voltage Vf		Reverse Current Ir	Dominant Wavelength		Luminous Intensity Iv			
									Typ.(V)	If(mA)		Max.(μA)	Vr(V)	λ D Typ.(nm)	If(mA)	Min. (mcd)	Typ. (mcd)
■ ■ SPR-54MVW	GaAsP on GaP	Red	60	20	60*1	3	-25 to +85	-30 to +100	2	10	10	3	572	10	2.2	6.3	10
	GaP	Yellowish Green	75	25					2.1								

* 1:Duty1/5, 200Hz

* Individual pieces are not connected together with tapings.

Dimensions

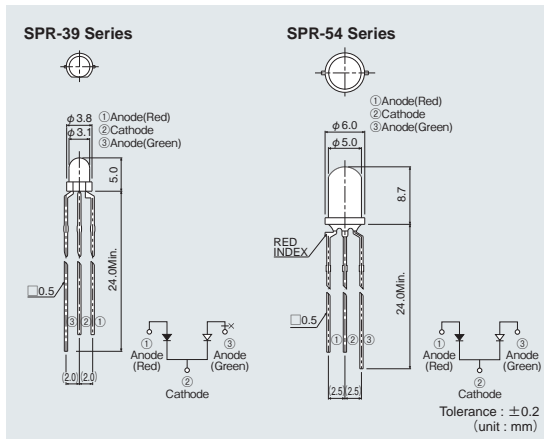

Recommended Solder Pattern

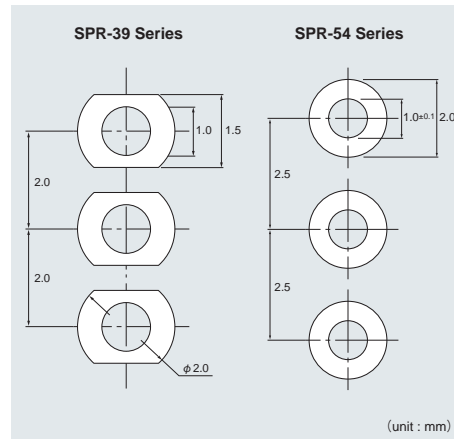

Viewing Angle

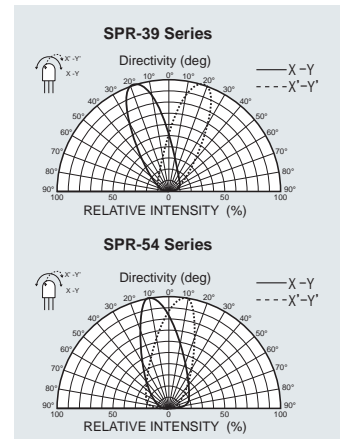

Electrical Characteristics Curves

Forward Current-Forward Voltage

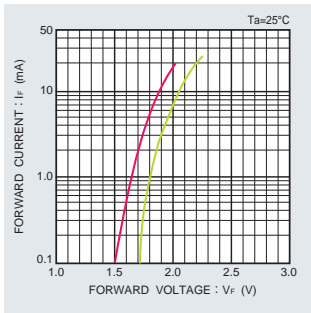

■ SPR-39MWW(V)
■ SPR-39MWW(M)

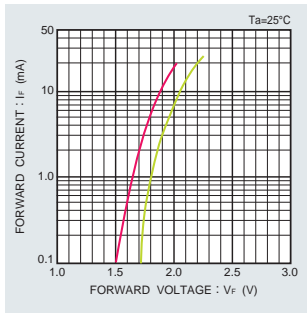

■ SPR-54MWW(V)
■ SPR-54MWW(M)

Luminous Intensity-Atmosphere Temperature

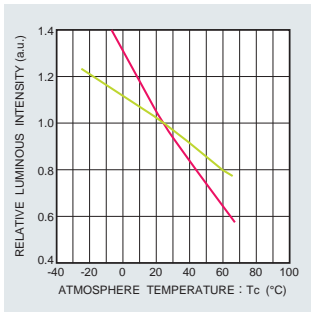

■ SPR-39MWW(V)
■ SPR-39MWW(M)

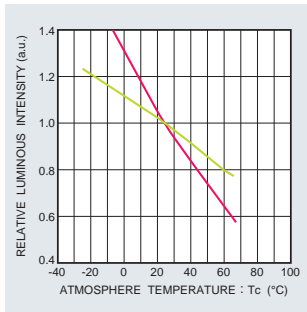

■ SPR-54MWW(V)
■ SPR-54MWW(M)

Luminous Intensity-Forward Current

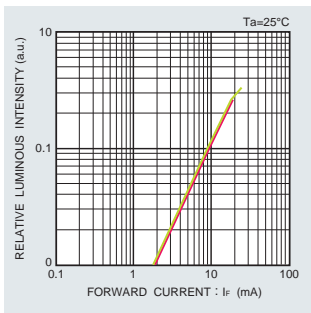

■ SPR-39MWW(V)
■ SPR-39MWW(M)

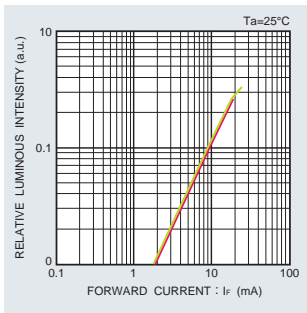

■ SPR-54MWW(V)
■ SPR-54MWW(M)

Derating

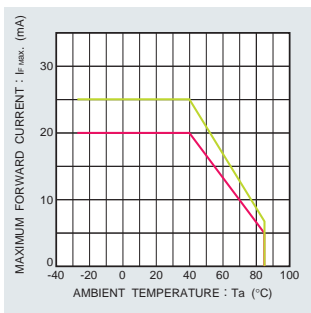

■ SPR-39MWW(V)
■ SPR-39MWW(M)

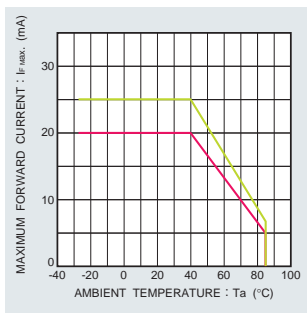

■ SPR-54MWW(V)
■ SPR-54MWW(M)

Part No. List

Part No.	Page	Part No.	Page	Part No.	Page
SLA-360MT	46	SLI-343YY	40	SLR343BCT	42
SLA-370MT	46	SLI-343YY(W)	40	SLR343BD2T	40
SLA-560MT	50	SLI-560DT	50	SLR343EC4T	42
SLA-570MT	50	SLI-560UT	50	SLR343ECT	42
SLA-580MT	48	SLI-560YT	50	SLR343WBC7T	42
SLA560BC4T	52	SLI-570DT	50	SLR343WBD2PT	40
SLA560BC7T	52	SLI-570U2T	50	SLR-56DC	52
SLA560BCT	52	SLI-570Y2T	50	SLR-56DU	52
SLA560BD2T	50	SLI-580DT	48	SLR-56MC	52
SLA560EC4T	52	SLI-580UT	48	SLR-56MG	52
SLA560ECT	52	SLI-580YT	48	SLR-56VC	52
SLA560WBC7T	52	SLR-322DC	56	SLR-56VR	52
SLA560WBD2PT	50	SLR-322DU	56	SLR-56YC	52
SLA580BC4T	48	SLR-322MC	56	SLR-56YY	52
SLA580BCT	48	SLR-322MG	56	SML-011DT	14
SLA580EC4T	48	SLR-322VC	56	SML-011UT	14
SLA580ECT	48	SLR-322VR	56	SML-011YT	14
SLB-25DU	59	SLR-322YC	56	SML-012D8T	14
SLB-25MG	59	SLR-322YY	56	SML-012DT	14
SLB-25VR	59	SLR-325DC	54	SML-012M8T	14
SLB-25YY	59	SLR-325DU	54	SML-012P8T	14
SLC-22DU	58	SLR-325MC	54	SML-012PT(A)	14
SLC-22MG	58	SLR-325MG	54	SML-012U8T	14
SLC-22VR	58	SLR-325VC	54	SML-012UT	14
SLC-22YY	58	SLR-325VR	54	SML-012V8T	14
SLI-325DC(W)	54	SLR-325YC	54	SML-012VT(A)	14
SLI-325DU(W)	54	SLR-325YY	54	SML-012WT(A)	14
SLI-325URC(W)	54	SLR-332DC	46	SML-012Y8T	14
SLI-325UR(W)	54	SLR-332DU	46	SML-012YT	14
SLI-325YC(W)	54	SLR-332MC	46	SML012BC4T	14
SLI-325YY(W)	54	SLR-332MG	46	SML012BCT	14
SLI-343D8C	44	SLR-332VC	46	SML012EC4T	14
SLI-343D8U	44	SLR-332VR	46	SML012ECT	14
SLI-343DC	40	SLR-332YC	46	SML-013UT	14
SLI-343DC(W)	40	SLR-332YY	46	SML-013YT	14
SLI-343DU	40	SLR-342DC	46	SML013BDT	14
SLI-343DU(W)	40	SLR-342DU	46	SML013WBDW	14
SLI-343M8C	44	SLR-342MC	46	SML-020MVT	34
SLI-343M8G	44	SLR-342MG	46	SML-022ML8T	34
SLI-343MC	40	SLR-342VC	46	SML022BUT	34
SLI-343MG	40	SLR-342VR	46	SML032RGB1T	38
SLI-343P8C	44	SLR-342YC	46	SML-110DT	24
SLI-343P8G	44	SLR-342YY	46	SML-110FT	24
SLI-343U8R	44	SLR-343DC	42	SML-110MT	24
SLI-343U8RC	44	SLR-343DU	42	SML-110PT	24
SLI-343UR	40	SLR-343MC	42	SML-110VT	24
SLI-343UR(W)	40	SLR-343MG	42	SML-110YT	24
SLI-343URC	40	SLR-343PC	42	SML-210DT	10
SLI-343URC(W)	40	SLR-343PG	42	SML-210MT	10
SLI-343V8R	44	SLR-343VC	42	SML-210PT	10
SLI-343V8RC	44	SLR-343VR	42	SML-210VT	10
SLI-343Y8C	44	SLR-343YC	42	SML-210YT	10
SLI-343Y8Y	44	SLR-343YY	42	SML-211DT	10
SLI-343YC	40	SLR343BC4T	42	SML-211UT	10
SLI-343YC(W)	40	SLR343BC7T	42	SML-211WT	10

Part No.	Page	Part No.	Page	Part No.	Page
SML-211YT	10	SML-A12Y8T	20	SML-R12M8T	18
SML-212DT	10	SMLA12BC7T	20	SML-R12P8T	18
SML-212U2T(A)	10	SMLA12WBC7W	20	SML-R12U8T	18
SML-212VT	10	SMLA13BDT	20	SML-R12V8T	18
SML-212WT(A)	10	SMLA13WBDW	20	SML-R12Y8T	18
SML-212YT	10	SMLC14WBEPW	23	SMLR13BDT	18
SML-310DT	8	SML-D12D8W	6	SMLR13WBDW	18
SML-310MT	8	SML-D12M8W	6	SMLT12BC7T	12
SML-310PT	8	SML-D12P8W	6	SMLT12WBC7W	12
SML-310VT	8	SML-D12U8W	6	SML-T13DT	12
SML-310YT	8	SML-D12V8W	6	SML-T13FT	12
SML310BAT	8	SML-D12Y8W	6	SML-T13MT	12
SML-311DT	8	SMLD12HBC7W	6	SML-T13PT	12
SML-311UT	8	SML-E12D8W	4	SML-T13UT	12
SML-311WT	8	SML-E12DW	4	SML-T13VT	12
SML-311YT	8	SML-E12M8W	4	SML-T13WT	12
SML312BC4T	8	SML-E12P8W	4	SML-T13YT	12
SML312BCT	8	SML-E12U8W	4	SMLZ13BDT(A)	16
SML312EC4T	8	SML-E12UW	4	SMLZ13EDT(A)	16
SML312ECT	8	SML-E12V8W	4	SMLZ13WBDAW	16
SML312WBCW(A)	8	SML-E12Y8W	4	SMLZ13WBDBW	16
SML-511DW	6	SMLE12BC7T	4	SMLZ13WBDCW(A)	16
SML-511UW	6	SMLE12EC6T	4	SMLZ13WBDDW(A)	16
SML-511WW	6	SMLE12WBC7W	4	SML-Z14D4T	16
SML-512CW(A)	6	SMLF13WBDW	22	SML-Z14DT(A)	16
SML-512DW	6	SML-J14DT	28	SML-Z14F4T	16
SML-512MW	6	SML-J14RT	28	SML-Z14FT(A)	16
SML-512PW(A)	6	SMLM12BC7T	12	SML-Z14M4T	16
SML-512UW	6	SMLM12WBC7W	12	SML-Z14MT(A)	16
SML-512VW	6	SML-M13DT	12	SML-Z14P4T	16
SML-512VW(A)	6	SML-M13MT	12	SML-Z14PT(A)	16
SML-512WW	6	SML-M13PT	12	SML-Z14U4T	16
SML512BC5T	6	SML-M13UT	12	SML-Z14UT(A)	16
SML-521MDW	32	SML-M13VT	12	SML-Z14V4T	16
SML-521MUW	32	SML-M13YT	12	SML-Z14VT(A)	16
SML-521MYW	32	SML-L13DT	28	SML-Z14Y4T	16
SML-522MD8W	32	SML-L14DT	28	SML-Z14YT(A)	16
SML-522MU8W	32	SML-P11DT	2	SMLZ14WBECW(A)	16
SML-522MUW	32	SML-P11MT	2	SPR-39MVW	60
SML522BUW	32	SML-P11UT	2	SPR-54MVW	60
SML-810MT	26	SML-P11VT	2		
SML-811DT(A)	26	SML-P11YT	2		
SML-811UT(A)	26	SML-P12DT	2		
SML-811WT(A)	26	SML-P12MT	2		
SML-812MT	26	SML-P12PT	2		
SML812BCT	26	SML-P12UT	2		
SML-A12D8T	20	SML-P12VT	2		
SML-A12DT(J)	20	SML-P12YT	2		
SML-A12M8T	20	SMLP12BC7T	2		
SML-A12MT(J)	20	SMLP12HBC7W	2		
SML-A12P8T	20	SMLP12WBC7W	2		
SML-A12U8T	20	SML-P24MUW	30		
SML-A12UT(J)	20	SMLP34RGB1W (3 colors, 4 terminals)	36		
SML-A12V8T	20	SMLP36RGB1W (3 colors, 6 terminals)	36		
SML-A12WT(J)	20	SML-R12D8T	18		

Part No. Configuration (Chip LEDs)

- When ordering, please specify the part number.
- Check each code in light of the tables shown below.
- Fill in the part number from the left, leaving any extra boxes on the right empty.
- ※Part names are appointed individually per each ranks.
- ※Please refer to Specifications sheet for details.

"," will be taken out for emitting color blue, bluish-green and white.

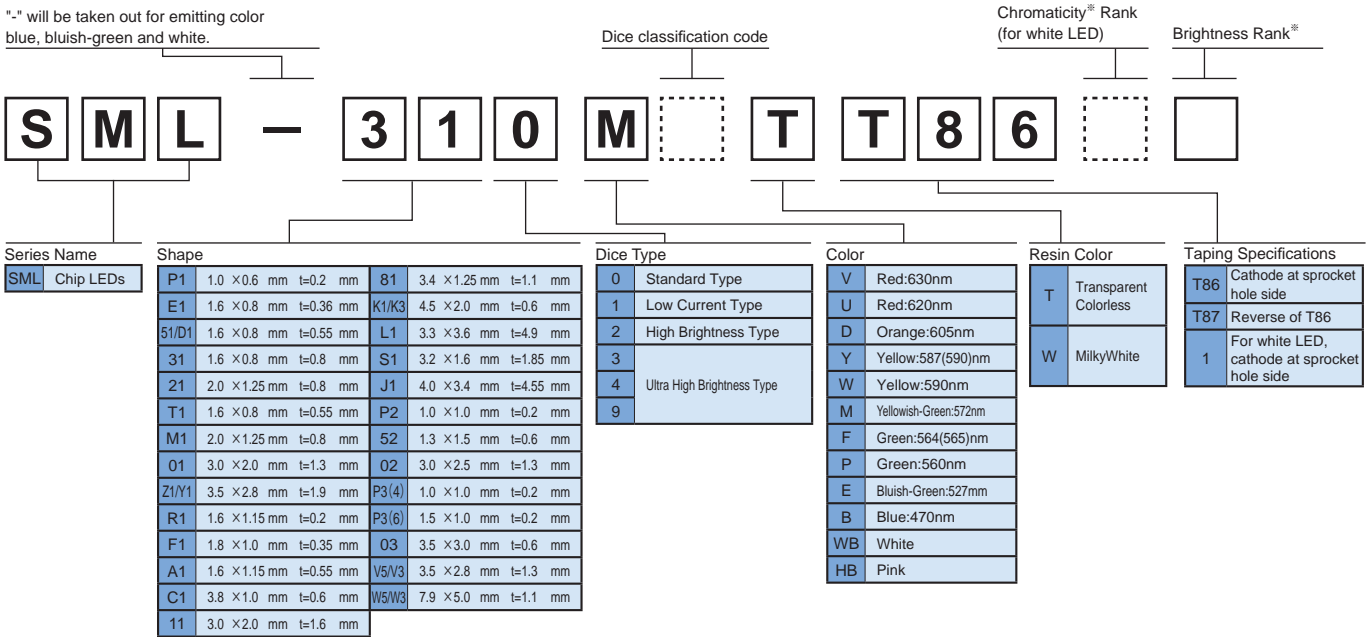

Part No. Configuration (Through-hole LEDs)

- When ordering, please specify the part number.
- Check each code in light of the tables shown below.
- Fill in the part number from the left, leaving any extra boxes on the right empty.
- ※Part names are appointed individually per each ranks.
- ※Please refer to Specifications sheet for details.

"," will be taken out for emitting color blue, bluish-green and white.

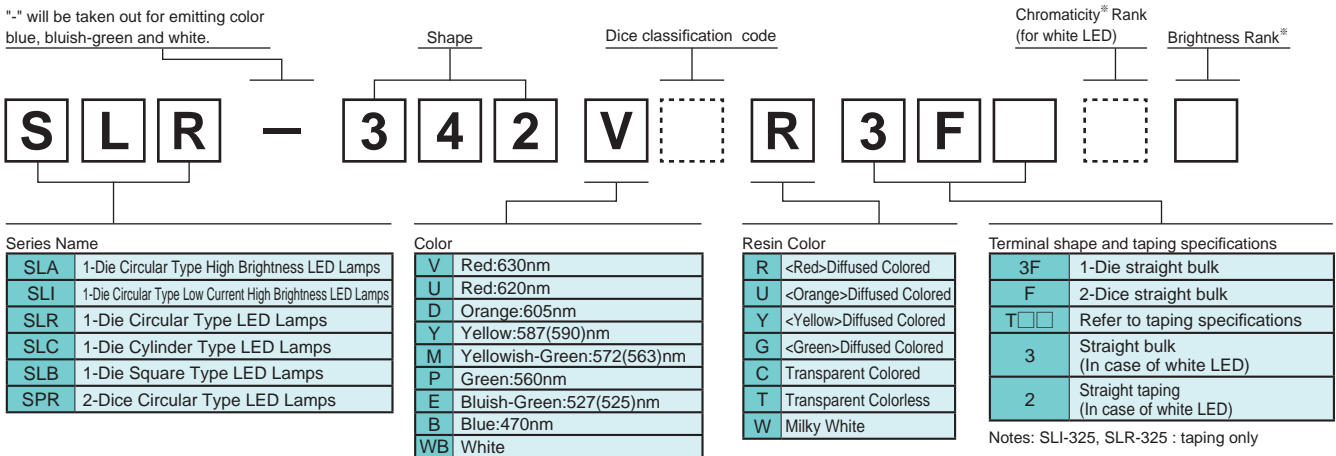

The content specified in this document is correct as of 1st October, 2010.

No copying or reproduction of this document, in part or in whole, is permitted without the consent of ROHM Co., Ltd.

The content specified herein is subject to change for improvement without notice.

The content specified herein is for the purpose of introducing ROHM's products (hereinafter "Products"). If you wish to use any such Product, please be sure to refer to the specifications, which can be obtained from ROHM upon request.

Examples of application circuits, circuit constants and any other information contained herein illustrate the standard usage and operations of the Products. The peripheral conditions must be taken into account when designing circuits for mass production.

Great care was taken in ensuring the accuracy of the information specified in this document. However, should you incur any damage arising from any inaccuracy or misprint of such information, ROHM shall bear no responsibility for such damage.

The technical information specified herein is intended only to show the typical functions of and examples of application circuits for the Products. ROHM does not grant you, explicitly or implicitly, any license to use or exercise intellectual property or other rights held by ROHM and other parties. ROHM shall bear no responsibility whatsoever for any dispute arising from the use of such technical information.

The Products specified in this document are intended to be used with general-use electronic equipment or devices (such as audio visual equipment, office-automation equipment, communication devices, electronic appliances and amusement devices).

The Products specified in this document are not designed to be radiation tolerant.

While ROHM always makes efforts to enhance the quality and reliability of its Products, a Product may fail or malfunction for a variety of reasons.

Please be sure to implement in your equipment using the Products safety measures to guard against the possibility of physical injury, fire or any other damage caused in the event of the failure of any Product, such as derating, redundancy, fire control and fail-safe designs. ROHM shall bear no responsibility whatsoever for your use of any Product outside of the prescribed scope or not in accordance with the instruction manual.

The Products are not designed or manufactured to be used with any equipment, device or system which requires an extremely high level of reliability the failure or malfunction of which may result in a direct threat to human life or create a risk of human injury (such as a medical instrument, transportation equipment, aerospace machinery, nuclear-reactor controller, fuel-controller or other safety device). ROHM shall bear no responsibility in any way for use of any of the Products for the above special purposes. If a Product is intended to be used for any such special purpose, please contact a ROHM sales representative before purchasing.

If you intend to export or ship overseas any Product or technology specified herein that may be controlled under the Foreign Exchange and the Foreign Trade Law, you will be required to obtain a license or permit under the Law.

ROHM Sales Offices

Contact us for further information about the products.

San Diego	+1-858-625-3630	Mexico	+52-33-3123-2001	Spain	+34-9375-24320	Taipei	+886-2-2500-6956
Atlanta	+1-770-754-5972	Düsseldorf	+49-2154-9210	Hungary	+36-1-4719338	Kaohsiung	+886-7-237-0881
Boston	+1-978-371-0382	Munich	+49-8999-216168	Poland	+48-22-5757213	Singapore	+65-6332-2322
Chicago	+1-847-368-1006	Stuttgart	+49-711-7272-370	Russia	+7-495-739-41-74	Philippines	+63-2-807-6872
Dallas	+1-972-473-3748	France	+33-1-4060-8730	Seoul	+82-2-8182-700	Thailand	+66-2-254-4890
Denver	+1-303-708-0908	United Kingdom	+44-1-908-272400	Dalian	+86-411-8230-8549	Malaysia	+60-3-7958-8355
Detroit	+1-248-348-9920	Espoo	+358-9725-54491	Shanghai	+86-21-6279-2727	Kyoto	+81-75-365-1218
Nashville	+1-615-620-6700	Salo	+358-2-7332234	Shenzhen	+86-755-8307-3008	Yokohama	+81-45-476-2121
Sunnyvale	+1-408-720-1900	Oulu	+358-8-5372930	Hong Kong	+852-2-740-6262		

R1080A

ROHM Co., Ltd.

21 Saiin Mizosaki-cho, Ukyo-ku,
Kyoto 615-8585 Japan

TEL : +81-75-311-2121 FAX : +81-75-315-0172

www.rohm.com

ROHM
SEMICONDUCTOR